

Weweni
Bemibizonitooon-g
Canada
Onaniizaanaab-oon

NAMEBINI-GIIZIS 2015

nwmo

NUCLEAR WASTE
MANAGEMENT
ORGANIZATION

SOCIÉTÉ DE GESTION
DES DÉCHETS
NUCLÉAIRES

Weweni Bemibizonitoong Canada Onaniizaanaaboon

Etegin Maanda Mazina'iganing

1	Maajitaawin	4
2	Ginaadimaadimin ji-bimibizonitooyang weweni gaa-aabajitoong iw naniizaanaaboon	5
3	Wegonen iw Canada Odinaakonigewin?	6
4	Bemibizonitoong Inaakonigewin	8
5	Wegonen iw gaa-aabajitoong naniizaanaaboo?	10
6	Aaniin ezhi-ataasong noongom?	12
7	Inagakeyaa Ayaangwaamiziwin: Gaa-aabajitoong Naniizaanaaboo Bemibizonitoong Gashkibijiganan	14
8	Gashkitoong Neniizaanakin	19
9	Bemibizonitoong Onji-akawaabanchigeng	21
10	NWMO's Enanokiwinan miinawaa Inendamaagoziwinan	24
11	Gakina Ningoji Gaa-dazhi-anokiingiban	27
12	Aabajichigewinan	30



Mikwendamowinan

WEWENI BEMIBIZONITOONG GAA-AABAJITOONG NANIIZAANAABOO GICHI-INENDAAGWAD

Bimibizonitoowin gichi-inendaagwad Canada odinaakonigewining niigaan gabeyi'ii gashkitoong gaa-aabajitoong naniizaanaaboo. Ningoji iidog Canada onaniizaanaaboo gaa-aabajitoong waa-dazhi-ataasong giishpin waa-mino-ateg de-inagindeg, daa-wenipanad apii bimibizonitoong iw naniizaanaaboo ayaagwaamizing wenji-ataasong Canada wenji-bimibizonitoong.

BIMIBIZONITOOWIN GE-AKAWAABANDAMING

Aapideg weweni daa-akawaabanchigaade nandagikenjigaadeg jibwaa-bimibizonitoong iw gaa-aabajitoong naniizaanaaboo. Apii bimibizonitoong naniizaanaaboo Canada Naniizaanaaboo igiw Genawaabandangig (CNSC) miinawaa Canada Obimibizonitoowin. Gaa-aabajitoong naniizaanaaboo gashkibijiganan nandagikendamowaad Miziwe-waasamowin Enokii jig (IAEA) ji-naniizaanasininig weweni. Bimibizonitoong Canada, Ontario, miinawaa Odenawan obimibizonitoowiniwaa da-nandagikenjigaadeni giishpin onizhishininig. Gaa-aabajitoong naniizaanaaboo Geshkitoojig (NWMO) daa-izhinoo'aanaawaa gaa-izhichigewaad iw naniizaanaaboo giishpin naniizaanasininig jibwaa-maajii-bimibizonitoong.

BIMIBIZONITOOWIN-INAAGONIGEWINAN DA-IZHITOONG JI-MINWENDAMOWAAD IGIW BEMAADIZIJIG

Apii onaabandaming waa-onji-ateg naniizaanaaboo gaa-aabajitoong waa-dazhi-ataasong, NWMO da-onaabandaanan iniw bimibizonitoowinan miinawaa miikanan apii onaabandaming waa-onji-ataasong. Apii inaakonigeng weweni waa-dazhi-bimibizonitoong miinawaa bimibizonitoowinan ge-onji-ganooniding inaakonigeng gakina awiya igiw bemaadizijig endanakiijig jiigi-miikanaang waa-dazhi-bimibizonitoong miinawaa giishpin waa-gagwedwewaad izhiwebadinig.

WEWENI GAA-BIMIBIZONITOONGIBAN MIZIWE NENDAGIKENJIGAADeg GAA-AABAJITOONG NANIIZAANAABOO

Bimibizonitoong naniizaanaaboo weweni izhichigem. Naanimidana baboon gaye awashime, Niizhdana-sagoons gashkibijiganan miinawaa awashime gakina ningoji gaa-aabajitoong naniizaanaaboo, miikanaang, ishkode-odaabaani-miikanaang, miinawaa jiimaaning. Canada gii-izhichige, miinawa geyaab izhinoo'amaage, weweni bimibizonitoong gaa-aabajitoong naniizaanaaboo, niibina gashkibijiganan gaa-ako-ozhichigaadegin 1960s. Miziwegamik miinawaa Canada, gaawiin awiya gii-gichi-godigoshinzii, gaawiin inaapinewinan, gaawiin awiya gii-nibosii gemaa gaye gaawiin maji-izhiwebazinoon agwajiiing apii etegin gaa-aabajitoong naniizaanaaboo-gashkibijiganan izhi-ayaagin.

1 Maajitaawin

Maanda mazina'igan ozhibii'igaade bimibizonitoong izhichigewinan apii Canada inaakonige wii-gashkitoong iw gaa-aabajitoong naniizaanaaboo gaa-ozhichigaadeg waasamowin ozhichigaadeg.

Gaa-aabajitoong Naniizaanaaboo Geshkitoojig (NWMO) gaa-ako-ozhi'igoon 2002 Naniizaanaaboo-waasamowin Wezhitoonijin noopinadoonijin iw Canada Onaniizaanaaboo-webinigewin-inaakonigewinini (NFWA). Odinaakonigewin wenji-atenig wii-onji-onizhishinigin Canadians ji-gashkitoong gabeyi'ii iw Canada gaa-aabajitoong naniizaanaaboo ji-odaapinigaadeg, ji-onizhishing, ji-onizhishing agwajiiing miinawaa ji-de-inagindeg.

NFWA waa-ayaang naniizaanaaboo-webinigewinini gaa-ozhitoonid ji-ozhitoowaad zhooniyaakewinan ji-diba'igewaad ji-gashkitoowaad gabeyi'ii iw gaa-aabajitoong naniizaanaaboo. Inagakeyi'ii iw inaakonigewin, Ontario Waasamowin, Hydro-Québec, New Brunswick Waasamowin Enokijig, miinawaa Atomic Waasamowin. Canada (AECL) ogii-ozhitoonan zhooniyaakewinan 2002, miinawaa

gii-maajii-dagonaan zhooniya endaso-biboon iw zhooniyaakewining. Onow zhooniyaakewinan wii-onji-aabajichigaadegin gakina inagakeyi'ii iw Canada odinaakonigewin, gaye bimibizonitoong gaa-aabajitoong naniizaanaaboo.

Canada gaa-aabajitoong onaniizaanaaboo weweni ate gaa-nitaa-ataasong ajina imaa wenji-ozhitoong naniizaanaaboo-waasamowin. Naniizaanaaboo-waasamowinagamigooon atemagadoon Ontario, Quebec miinawaa New Brunswick, gaye AECL's naniizaanaaboo-gikenjigewigamigooon Ontario miinawaa Manitoba.

NWMO's odinendamaagoziwin onji-izhitoong iw bimibizonitoowin-izhichigewin, ji-onji-bimibizonitoong weweni gaa-aabajitoong naniizaanaaboo imaa wenji-ataasong ajina wii-atoong imaa naawiyi'iiing wii-gichi-apiichising anaamikiing ataaawining.

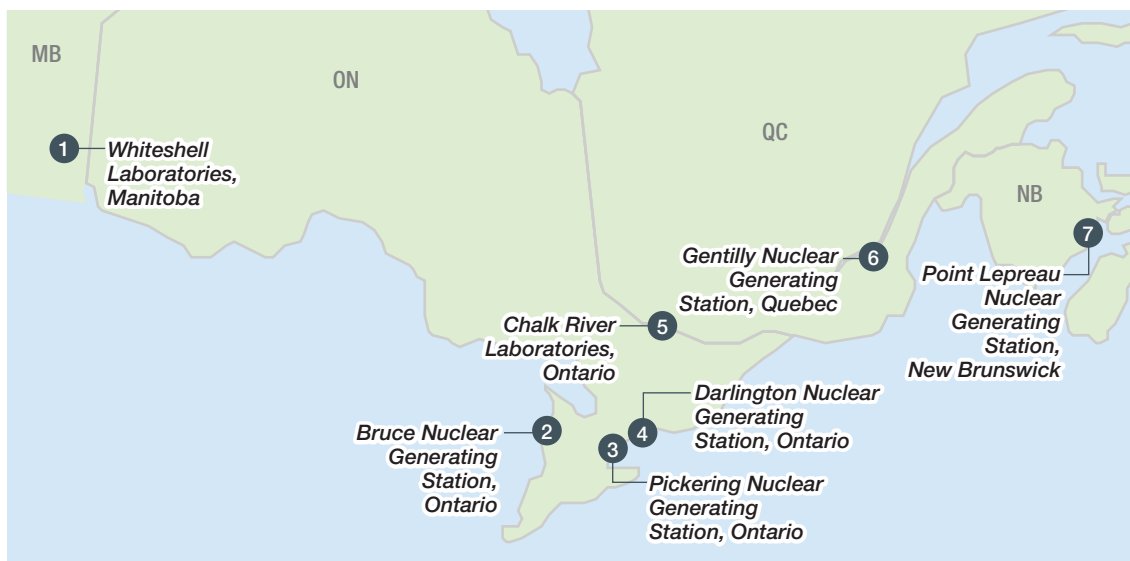

Canada's niizhwaaswi naniizaanaaboo-gamigooon

2 Ginaadimaadimin ji-bimibizonitooyang weweni gaa-aabajitoong iw naniizaanaaboon

Mii gashkitoong gabeyi'ii iw gaa-aabajitoong naniizaanaaboo gakina awiya inendamaagozi. Canada odinaakonigewin ji-gashkitoong gaa-aabajitoong naniizaanaaboo gabeyi'ii mii maanda ezhichigeng wenji-ataasong noongom wenji-bimibizonitoong inagakeyaa imaa naawiyi'iing ningoji. Inaakonigewinan ji-onji-bimibizonitoong gaa-aabajitoong naniizaanaaboo ji-minwendamowaad bemaadizijig miinawaa wii-mino-izhiwebak agwajiing apane go. Gaa-aabajitoong Naniizaanaaboo Geshkitoojig (NWMO) obimibizonitoowiniwaa gechi-nandagikenjigaadenig wii-onzhishininig akawaabanchigaadenig, miinawaa gaye bemaadizijig waa-waawiindamawindwaa ji-nisidotamowaad miinawaa wiindamawindwaa booch waa-izhichigeng, gagwedwewinan miinawaa naagadawendamowinan. Ginandomigoo ji-dazhiikaman.

Imaa waa-gichi-apiichising anaamikiing iw ataasowin gaawiin mashi onaabanchigaadesinon, miinawaa gaa-aabajitoong naniizaanaaboo wii-maajii-bimibizonigaadesinon biinish baamaa. Aanawi, maajii-ganoonidim izhi-inaakonigeyaang gaa-aabajitoong naniizaanaaboo ji-bimibizonitooyaang. Maanda mazina'igan waa-onji-ganoonidiyaang, waa-izhichigeyaang:

- » Waa-miinigooyan wiindamaagewin bimibizonitoong weweni iw gaa-aabajitoong naniizaanaaboo Canada;
- » Ji-dazhiikaming gagwedwewinan noondaming waa-izhi-bimibizonitoong baamaa gaa-aabajitoong naniizaanaaboo Canada wenji-inaakonigeng;
- » Ji-bi-dazhiikaman ganooniding.

Bi-ayaan niinawind wenj-dazhiikamaang besho giin, niywaachi' NWMO Netaawichigejig imaa NWMO Anokiiwigamigoong besho giin, gemaa gaye ganawaabandan NWMO gikendaaso-makakoong ji-nandagikendaman gemaa gaye maada'ookiin gidinendamowin.



3 Wegonen iw Canada Odinaakonigewin?

Canada odinaakonigewin ji-gashkitoong gabeyi'ii gaa-aabajitoong naniizaanaaboo gekenjigaadeg Gichi-izhi-gashkijigewin (APM). Maanda inaakonigewin gii-bi-ateni niso-biboonagadinig gii-onji-ganoonidiwaad Canadians 2002 biinsh 2005, waabanda'igaadeni weweni gaa-goji-izhichigeng miziwekamig miinawaa ezhi-ayaanig enendamowaad bemaadizijig. Gichi-ogimaawiwin ogii-onaabandaan APM ji-aawaninig Canada odinaakonigewin Ode'imini-giizis 2007.

Naniizaanaaboo Webinigewin Geshkitoojig (NWMO) booch waa-izhichigewaad ayaangwaamiziwin – ji-akawaabamaawaad bemaadiziniin miinawaa aki giishpin etenig gichi-waasamowin gaa-aabajitoong naniizaanaaboo. Gaa-aabajitoong naniizaanaaboo daa-badagwana'igaadeni miinawaa daa-zagakinigaadeni ayaawaad bemaadizijig miinawaa ji-mino-izhiwebadinig agwajiing apane ganabaj. Mii go noongom inaakonigeng ji-ganawendaming, naawiyi'iiing ji-badagwana'igaadeg miinawaa ji-zagakinigaadeg Canada gaa-aabajitoong onaniizaanaaboo imaa ge-gichi-apiichising anaamikiing ezhi-ayaagin asiniin.

Maanda waakaa'iganing da-atewan atasowin miinawaa Gichi-nitaawichigewin ji-maawanji'iding gakina awiya ji-izhi-ganooniding.

Canada odinaakonigewining, NWMO wii-mikawaan gekenjigenid wii-gaagiigidonid waakaa'iganing. NWMO gii-maajitaa wii-onaabandaming ningoji wii-atenig Namebini-giizis 2010 ji-mikaming weweni ningoji waa-onji-ataasong. Nandawaabandaming gabeyi'ii nandagikenjigeng miinawaa gaganooniding odenawan miinawaa gichi-gikenjigewinan jibwaa-onaabandaming iw atasowin.

Maanda gichi-ozhigewin izhichigewin ji-onji-zhooniyaakeng imaa miinawaa Ontario wenji-aabajitoong. Iw inaakonigewin gaa-izhitoong ji-aabajitoong maamawi imaa de-izhi-asiniikaag. Iw izhichigewin wii-maajiiskaanig eta giishpin minwendamowaad bemaadizijig, besho endanakiwaad Anishinaabeg miinawaa Waasaakodejig, miinawaa besho odenawan maamawi waa-onji-izhichigewaad.

NWMO wii-nitaawichigewaad wii-akawaabamindwaa wii-ganawendamowaad mino-ayaawin, wawiingeziwin miinawaa wii-bami'aanjin bemaadiziniin miinawaa ji-mino-izhiwebadinig agwajiing.

Apii bimibizonitoong gaa-aabajitoong naniizaanaaboo ekawaabanchigaadeg. Apii bimibizonitoong gaa-aabajitoong naniizaanaaboo imaa niizhwaaswi atasowinan imaa inagakeyaa ezhaamagak gichi-ataasowining megwaa Canadian Naniizaanaaboo Wewiingezijig booch ji-miigiwewaad iw bimibizonitoowini-mazina'igan ji-bimibizonitoong gaa-aabajitoong naniizaanaaboo miinawaa ji-gashkitoong iw waakaa'igan. Giishpin geyaabi waa-gikendaman APM miinawaa iw izhichigewin, daga izhaan www.nwmo.ca.

Maanda Ataasowin Epiichising Anaamikiing

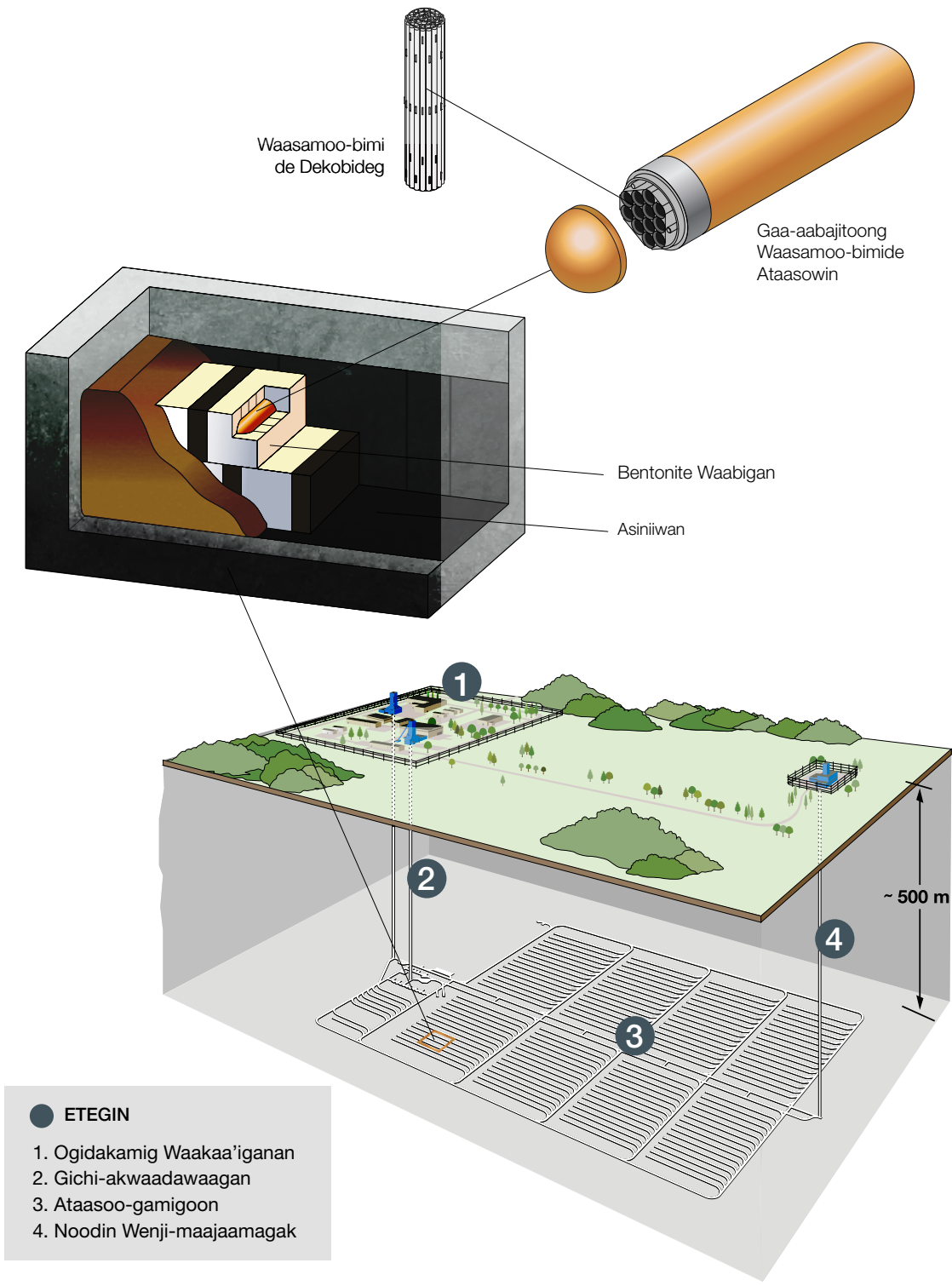

4 Bemibizonitoong Inaakonigewin

Naniizaanaaboo Webinigewin Geshkitoojig (NWMO) wii-izhinoo'awaawaan ekawaabanchigenijin miinawaa bemaadizinijin iw ayaangwaamiziwin miinawaa akawaabanchigewin bimibizonitoong izhichigewin jibwaa-maajii-bimibizonitoong iw gaa-aabajitoong naniizaanaaboo.

Giishpin onaabandaming ningoji de-agingdeg waa-onji-ataasong, miikana waa-onji-bimibizonitoong ge-onaabandaming gemaa gaye ge-onji-ozhichigaadeg miikana ji-onji-bimibizonitoong gaa-aabajitoong naniizaanaaboo ataasoowigamigoong Canada ge-izhaamagak imaa gichi-ataasowining.

Giishpin Canada onaniizaanaaboo-waasamowinikewigamigoon geyaabi wii-onizhishingin biinish ishkwaabimaadakin, miinawaa inaakonigeng wii-biinitoong, miinawaa enagingdeg gaa-aabajitoong naniizaanaaboo booch wii-bimibizonitoong imaa ezhaamagak ataasowining ganabaj 4.6 midaaswaak dasing midaaswaak gashkibijiganan, giishpin wii-nitaa-gashkitoong niigaan Canada odinaakonigewin gii-izhitoon ji-gaskitoong gaa-aabajitoong naniizaanaaboo. Gaawiin gaa-aabajitoong naniizaanaaboo agwajiyi'iing Canada wii-achigaadesinon imaa Wenji-gichi-izhi-gashkitoong (APM) ataasowining.

NWMO gii-ozhitoon izhichigewin ji-dibagindaming wii-achigaadeg weweni ningoji. Maanda izhichigewin ganawaabandaming bimibizonitoowin inagakeyi'iin wii-achigaadeg ningoji, miikanan, aanike-miikanan miinawaa anooj dinowa bimibizonitoowin. NWMO gii-maajii-dibagindaanan izhichigewin inagakeyi'iin, gaye odenawan bemaadizijig enendamowaad wii-nandagikendamowaad nawaj miinawaa bakaan odenawan gaye. Iw netamising dakokiwin

ji-aabajitoong zhaazhiye etegin nandagikenjigewi-mazina'iganan ji-nandagikendaming iw bimibizonitoowin inagakeyi'iin giishpin etegin gemaa gaye iw bimibizonitoowin daa-ozhichigaadeg. Iwiw dibagindaasowinan izhichigewining awashime wiindamaagewin, miinawaa dinowa bimibizonitoowin, miikana miinawaa gashkitoowin nandagikenjigewinan.

Naanimidana baboon miinawaa awashime, gii-atewan Niizhdana-sagoons miinawaa awashime bimibizonitoowinan gakina ningoji gaa-aabajitoong naniizaanaaboo, miikanaang, ishkodaabaani-miikanaang miinawaa nibiikaang. NWMO ganawaabandaanan miikana miinawaa ishkodaabaani-miikana wenji-ataasong ajina biinish imaa odenawaning giishpin waa-onji-ataasong imaa. Netamising genawaabandaming iw bezhig gemaa gaye niizh dinowa bimibizonitoowinan wii-onaabandaming wii-onji-bimibizonitoong gaa-aabajitoong naniizaanaaboo imaa ningoji-wenji-onaabandaming ningoji.

Apii onaabandaming wii-onji-ataasong, NWMO da-izhinoo'aanan wenzhishininig bimibizonitoowinan gaa-inendaming miinawaa miikanan imaa waa-onji-ataasong enendaming. Iw izhichigewining ganooniding miinawaa inendaming gakina awiya imaa naasaab inendaming ge-bimibizonitoong miinawaa wii-gagwedweng gemaa gaye wii-naagadawendaming daa-onji-ganooniding.

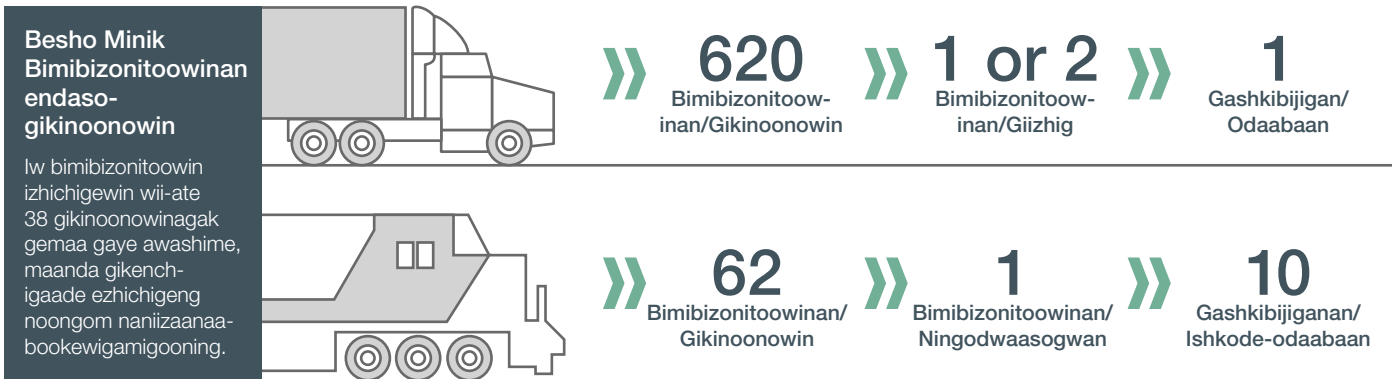

Apii ataasowin maajitaamagak, gaa-aabajitoong naniizaanaaboo da-achigaade imaa wenji-ataasong izhiseg memeshkwad ji-ataasong weweni apii bagamibideg. Onaabandamowinan ji-bimibizonitoong aabajitoong iniw anooj bimibizonitoowinan wii-naagadawendamingwen giishpin wenji-ataasong gaa-onaabandaming awiya odataasowining.

Apii wenji-ataasong onaabandaming, NWMO booch daa-izhinoo'amaage wenaabandaming dinowa bimibizonitoowin miinawaa miikana ji-onizhishingin onji-onaabandaming. NWMO aapideg wii-atoon wenizhishininig wawiingeziwin bimibizonitoowin izhichigewin miinawaa nitaa-ozhiitaawin giishpin awiya wiisagishininig. Gichi-izhichigeng ji-barni'indwaa bemaadizijig miinawaa wii-mino-izhiwebadinig agwajiing, miinawaa ji-dazhiikaming gagwedwewinan miinawaa inendamowinan eyaamowaad bemaadizijig. Maanda gaye izhinoo'amaageng:



Mashkawisin,
gaa-gagwejitoo
g miinawaa
gaa-gikenjigaad
eg
bimibizonitoong
gashkibijigan



Booch
gaa-nanaa'itoong
ji-gichi-bimibizonit
oong miinawaa
ishkode-odaabaani
ng
ji-dazhi-ayaangwaa
mizing miinawaa
akawaabanchigeng



Bimibizonitoowin
Akawaabanchige
win
Inaakonigewin
atemagad



Wewiib
Naadamaagewin
Inaakonigewin
atemagad



Booch
gaa-nanaa'itoong
ji-aaming
bimibizonitoowini
-mazina'igaans



Memeshkwad
agindaasong
miinawaa
asigigindaasong
ji-onji-inaakonige
ng

Mii waa-gikinoo'amaaged odinaakonigewin, Canada onoopinadoonan Miziwekamig Atomic Waasamowin Maawanji'idiwin iw gikinoo'amaagewin miinawaa gikinoowaabanchigewinan, miinawaa ganawaabandaanan bimibizonitoong izhichigewinanani giishpin etenig neniizaanadinig United Kingdom, Sweden, Germany, France, miinawaa United States.

Noopinadoong miziwekamig gikinoowaabanchigewinan, Canadian Naniizaanaaboo Ayaangwaamiziwin Ezhichigejjig (CNSC) miinawaa Bimibizonitoowin Canada manezin NWMO ji-izhinoo'amaagenid gakina gegoo ayaangwaamiziwinini miinawaa akawaabanchigewinini inaakonigewinini jibwaa-miigiwed CNSC bimibizonitoowini-mazina'igaans wii-bimibizonitoong gaa-aabajitoong naniizaanaaboo biinish wenji-ataasong (waabandan Jakibii'igan 9, *Bimibizonitoowin Akawaabanchigewin miinawaa Gichi-akawaabanchigewin*). IGaye apii gashkitoong akawaabanchigewinan omaa ishpinimig wezhibii'igaadegin, NWMO wii-ayaan gaye wii-izhinoo'amaaged odinaakonigewinan ji-ayaangwaamizing, gikinoo'amaagewin miinawaa wewiib naadamaagewin.

NWMO nisidotaan ayaangwaamiziwin miinawaa akawaabanchigaadenig bimibizonitoong izhichigewin niibina gegoo etenig, gaye (gaye onow anaamiyi'iin):



Gichi-apiitendaag
ozij-ig miinawaa
netaa-gikinoo'am
aag-oojig
enokijig
miinawaa
wedaabii'ijewig



Ayaangwaamiz-iwinan
, gaye izhichigewinan
maji-izhiwebak
agwajiing miinawaa
miikanaang, weweni
achigaazowaad
odaabaanag,
miinawaa miikana
dibendaagwak



Gikinoo'amaad-iwi
n miinawaa
maamawi
izhichigewinan
gichi-odenaw
miinawaa
odenawan
nayaadamaag-ejig



Waandamaag-ooj
ig miinawaa
Endazhiikangig
megwaa
inaakonigeng
miinawaa
anokiing



APM izhichigewin
dibagindaasowin
miinawaa
nanaa'itoowin

5 Wegonen iw gaa-aabajitoong naniizaanaaboo?

Gaa-aabajitoong naniizaanaaboo gaa-izhi-ozhichigaadeg apii naniizaanaaboo-waasamowini-gamigoon waasamowin ozhichigaadeg. Geyaabi naniizaanadini naniizaanaaboo-waasamowin gabeyi'ii, miinawaa booch daa-bisagobiiyaani miinawaa daa-boonichigaadeni waasa bemaadizijig daa-ayaawaad miinawaa mino-aki waasa daa-ateg ganabaj apane go. Mii sa epiichi-naniizaanak naniizaanaaboo-waasamowin eshkam bebangii gomaapii, odenaang naniizaanaaboo-waasamowin (maamawi gaye naniizaanaaboo bichibowin) geyaabi, miinawaa gaa-aabajitoong naniizaanaaboo geyaabi da-ate wii-naniizaanak gabeyi'ii. Onjida, gaa-aabajitoong naniizaanaaboo daa-gashkitoong weweni ganabaj apane go.

CANDU gaa-aabajitoong naniizaanaaboo gaawin nibiiwanzinon miinawaa noodin aawanzinon – mii zitawegak. Canada miinawaa miziwekamig akawaabanchigewining, gaawin da-jaagidesinon, da-baashkidesinon gemaa gaye ganage da-naniizaanazinon.

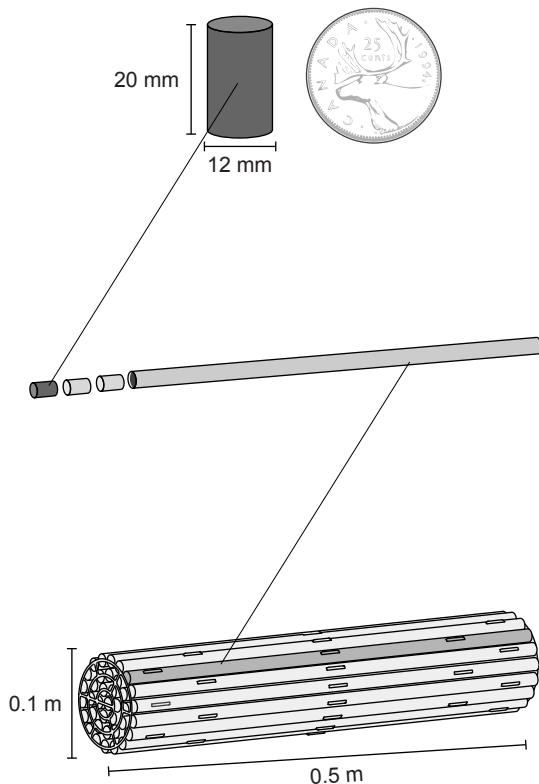

Giiishpin nawaj gegoo waa-nandagikendaman maanda izhichigewin, daga izhaan imaa Canadian Naniizaanaaboo Wawiingeziwin Enokijig waasamowin-asabiing gikendaasoo-makakoong:
www.nuclearsafety.gc.ca/eng/resources/radiation/index.cfm.
The Omaa mazina'iganing ji-gikendaming izhichigewinan izhitoong iw naniizaanak waasamowin.

Naniizaanaaboo-waasamowin Asin

Naniizaanaaboo-waasamowin-asiniin ozhichigaadeg aabajitoong uranium dioxide biisboojigan, gibozaming gizhaabikiziganing waasowin-asin ji-mashkawaag, ji-gichi-mashkawaag waabigan ji-aawang. Waabigan ayi'iin gaawin wenipanazinon ningaabaaweg miinawaa gaawin daa-bakiboodesinon gaye megwaa gichi-gizhideg.

Naniizaanaaboo-waasamowin Ozhibii'iganaatig

Naniizaanaaboo-waasamowin-asiniin atewan biinjii'iing zircaloy okijaabikong, ozhibii'iganaatig ezhinikaadeg. Ozhibii'iganaatigoon maamawi dagwaabikizigaadewan ji-aawang okijaabik naniizaanaaboo-waasamowin gashkibijigan.

Naniizaanaaboo-waasamowini-gashkibijigan

Gakina gashkibijiganan ozhichigaadegin biinjii'iing naniizaanaaboo-waasamowin-ozhibii'iganaatigoon miinawaa zwaangang, egwaagoobikazinoog, zicaloy ezhinikaadeg. Naniizaanaaboo-waasamowini-gashkibijiganan naasaab inigokwaawan dibishkoo mishi miinawaa 24 kilograms apiitinigwadoon. Jibwaa-achigaadeg wenji-waasamowinikeng, bangii naniizaanad iw waasamowin imaa gashkibijiganan. Iw naniizaanaaboo-waasamowin gashkibijiganan epiichi-naniizaanakin 0.05 mSv/h. Apii anokiimagakin wenji-waasamowinikeng, bebezhiig gashkibijiganan de-ozhichigaadeg waasamowin waa-aabajitoong imaa 100 waakaa'iganan ningo-gikinoonowin.

Wawiingezing Gashkitoong iw Neniizaanak Megwaa Gakina Ezhichigeng Naniizaanaaboo-waasamowinikeng

Apii gaa-aabajitoong naniizaanaaboo bakwadinaming wenji-waasamowinikeng, aapiji neniizaanak waasamowin. Eshkam bangii naniizaanad iw waasamowin bimisek, gaa-aabajitoong naniizaanaaboo geyaabi wii-naniizaanad gabeyi'ii niibina ningodwaak gikinoonowinan ganabaj awashime gaye. Maanda neniizaanak gaa-gashkitoong weweni.

Neniizaanak waasamowin wenjibaamagak gaa-aabajitoong naniizaanaaboo wewiib eshkam bangii naniizaanad apii maajidoong wenji-waasamowinikeng. 99 daswewig dibach miinawaa awashime iw waasamowin naniizaanazinoon ishkwa-midaaso-gikinoonowinagak. Geyaabi aanawise bimisek.

Canada odayaan akawaabanchigeng izhichigewin ji-dibendaming dazhiikaming iw gaa-aabajitoong naniizaanaaboo. Gaa-aabajitoong naniizaanaaboo weweni gashkitoon miinawaa badagwana'aan ji-ayaasig awiya badagwana'asininig naniizaanaaboo-gashkibijigan. Canada, gaa-aabajitoong naniizaanaaboo weweni gii-gashkitoonaaban gabeyi'ii memidaaso-gikinoonowinagadinig wenji-naniizaanaaboo-waasamowinikeng niibina waakaa'iganan. Wenji-waasamowinikeng, naniizaanaaboo

weweni dakaagamising, badagwana'aming atasowining wenji-waanashkobiiyaagin. Imaa memeshkwad gomaapii eyaag naniizaanaaboo-webinigewin wenji-gashkitoong waakaa'iganan, badagwana'aming gaa-gashkitoong gii-aabajitoong mechaagin atasowinan asiniikaan miinawaa biywaabik aawangin gii-aabajitoong gii-ozhigaadegin. Nibi miinawaa asiniikaan onizhishinoon badagwana'aming neniizaanak waasamowin. Bimibizonitoong, iw gashkibijigan gaa-izhi-ozhichigaadeg ji-badagwana'aming weweni iw gaa-aabajitoong naniizaanaaboo. Miinawaa gomaapii, da-badagwana'igaade weweni atasong gichi-anaamikiing atasowining etegin iniw bagwaji-aasamisagoon miinawaa gaa-ozhichigaadegin aasamisagoon.

Izhichigewinan aabajitoong ji-bami'indwaa bemaadzijig miinawaa ji-ganawendaming aki giishpin atening naniizaanaaboo-waasamowin ji-naniizaanadinig eshkam bangii, ji-atenig waasamowin waasa miinawaa weweni ji-badagwana'aming. Onow izhichigewinan aabajitoong gakina ezhichigeng gashkitoong iw gaa-aabajitoong naniizaanaaboo, bimibizonitoong gaye.

6 Aaniin ezhi-ataasong noongom?

Gaa-aabajitoong naniizaanaaboo badagwana'igaade gomaapii wenji-nibiiwang nibiing gemaa gaye wenji-baateg ataasowining wenji-waasamoo-naniizaanaabookeng.

Apii gaa-aabajitoong naniizaanaaboo maajidoong wenji-waasamowinikeng, mii ayaawang webinigewin. Iw waasamowin naniizaanad mii waa-onji-gashkitoong weweni. Iw gaa-aabajitoong naniizaanaaboo nakawe achigaade gaa-izhi-ozhichigaadeg iw wenji-waanashkobiiyaag wenji-waasamowinikeng imaa eshkam dakaagamin miinawaa eshkam bangii naniizaanad. Ishkwaa-niizhwaaswi gemaa gaye ishkwa-midaasogikinoonowinagak, geyaabi daa-ate wenji-waanashkobiiyaag, gemaa gaye ningoji, achigaade miinawaa weweni gashkitoong wenji-baateg ataasowining waakaa'iganan wenji-mazina'igaansikeng waa-aabajitoong memeshkwad bebezhi imaa waasamowinikewigamigoon. Gakina waasamowinikewigamigoon imaa wenji-ayaawaad Canadian

Naniizaanaaboo Ayaangwaamiziwin Enanokijig- wenji-atenig mazina'igaans imaa naniizaanaaboo-webinigewigamig ji-ataasong wenji-baatenig weweni ataasom iw gaa-aabajitoong naniizaanaaboo. Onow waakaa'iganan akawaabanchigaadeni ji-mino-ayaawaad bemaadizijig miinawaa ji-mino-izhiwebadinig agwajiiing, miinawaa ji-gikendaming gakina gegoo onizhishing wii-onji-inaakonigeng wii-akawaabanchigeng omaa miinawaa gakina ningoji.

Noongom Canada, atewan ganabaj 2.5 midaaswaak dasing midaaswaak gaa-aabajitoong naniizaanaaboo gashkibijiganan weweni atewan ataasong wenji-waanashkobiiyaagin gemaa gaye wenji-baategin asinii-ataasowinan, gichi-ataasowinan gemaa gaye ataasoowigamigoon.

Gaa-aabajitoong naniizaanaaboo ataasong nibiing – nibi onji-dakibiisingin naniizaanaaboo-gashkibijiganan miinawaa megwaa badagwana'aming weweni.



Ontario
Waasamowinikewin
Gaa-aabajitoong
Naniizaanaaboo Baateg
Wenji-ataasong



Point Lepreau Bayaateg
Wenji-ataasong
gichi-ataasowinan



Gentilly-2 Bayaategin
Ataasoowigamigoon



7 Inagakeyaa Ayaangwaamiziwin: Gaa-aabajitoong Naniizaanaaboo Gashkibijiganan

Wawiingeziwin ozhichigaade gakina ningoji naniizaanaaboo wenji-bimibizonitoong, nakawe bimibizonitoowin gashkibijigan izhitoowin. Gaa-aabajitoong naniizaanaaboo bimibizonitoong gashkibijiganan izhi-ozhichigaadeni miinawaa goji-gikenchigaadeni ji-mino-ayaawaad bemaadizijig apii anokiing, miinawaa giishpin awiya bichi-doodang. Canadian Naniizaanaaboo Ayaangwaamiziwin Enanokijig (CNSC), uaabajitoong miziwekamig goji-gikenchigaadenig gikinoowaabanchiganan, wenji-inendamaagoziwaad ji-gikendamowaad bimibizonitoowin gashkibijigan miinawaa ji-gikendamowaad waa-izhi-ozhitoong, wenji-ozhibii'igaadenig wii-aabajitoong bebezhiig gashkibijiganan, miinawaa ganawaabandamowaad iw gashkibijigan gashkitoong izhichigewinan.

Aanind iniw gaa-aabajitoong naniizaanaaboo bimibizonitoong gashkibijiganan gaa-gikenchigaadegin ji-aabajichigaadegin Canada, gaye Gaa-aabajitoong Naniizaanaaboo Bimibizonitoong Gashkibijigan (UFTP) miinawaa iw Bayaateg Ataasowin Bimibizonitoong Gashkibijigan (DSC-TP), wayaabanda'aming imaa mazina'iganing 15. Jibwaa-aabajitoong iw bimibizonitoong gashkibijigan Canada, gaa-izhi-ozhichigaadeg daa-gikenjigaade imaa CNSC ji-onizhishing ganawaabanchigaadeg, gaye atewan miziwekamig ayaangwaamiziwin gikinoowaabanjiganan. Waa-ayaaming goji-gikendamowinan ji-waabanjigaadeg izhi-ayaag iw gashkibijigan giishpin wii-biigosig, wii-jaagideg miinawaa wii-agwandeg.

Apii gakina gegoo onizhishing weweni wii-izhi-ozhichigaadeg

miinawaa wii-goji-gikendaming, CNSC onji-miigiwen mazina'igaans gii-izhi-ozhichigaadenig gashkibijigan. Iw mazina'igaansing ozhibii'igaade izhichigewinan waa-izhi-ozhichigaadeg, aabajichigaadeg miinawaa gashkitoong iw bimibizonitoowin gashkibijigan. Iw mazina'igaans wiindamaagemagad ozhibii'igaadeg gaa-gikenjigaadegin iniw ayi'iin gashkibijiganing. Onizhishin iw mazina'igaans naano-gikinoonowinagak. Ishkwaa-naano-gikinoonowinagadinig, iw Naniizaanaaboo Webinigewin Geshkitoojig (NWMO) daa-izhichigewag miinawaa iw mazina'igaans waa-ayaamowaad iw gashkibijigan mazina'igaans.

NWMO ganawaabandaanaawaa bimibizonitoong gaa-aabajitoong naniizaanaaboo aabajitoowaad wenzhishininig UFTP miinawaa DSC-TP mazinabii'iganan.

Gaa-aabajitoong Naniizaanaaboo Bimibizonitoong Gashkibijigan

UFTP atewan niswi booch ayi'in: wiyaw, giba'igan miinawaa waa-biigosisig ayi'ii. Wiyaw miinawaa giba'igan ozhichigaadegin biiwaabik ayaawangin miinawaa aasamisagoon gegaa 30 diba'igaans apiitaabikadoon. Giba'igan agwaabika'igaade wiyawing 32 apa'iganan. Waa-biigosisig ayi'ii gii-ozhichigaadeg gii-aabajitoong misko-mitig naawiyi'ii miinawaa biiwaabik giiwitaayi'ing. Biiwaabik wiyaw miinawaa giba'igan wenji-badagwana'igaadeg, miinawaa waa-biigosisig. Waa-biigosisig ayi'ii gii-zhi-ozhichigaade ji-mino-ayaagin wiyaw miinawaa giba'igan giishpin waa-bichi-doodaming. Waa-aabajitoong miinawaa iw gashkibijiganing 192 gaa-aabajitoong gashkiiginiganan miinawaa gegaa 35 diba'igan epiitinigwak boozitoong.

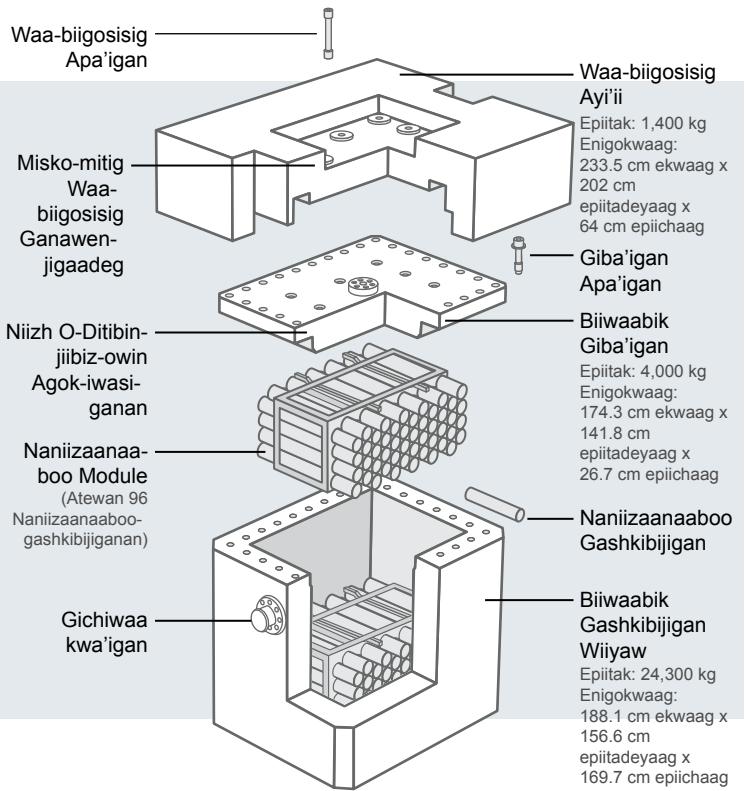

Wenji-baateg Ataasowin Bimibizonitoong Gashkibijigan

Epiitak: 100,300 kg
Enigokwaag:
367 cm ekwaag x
337 cm epiitadeyaag x
595 cm epiichaag

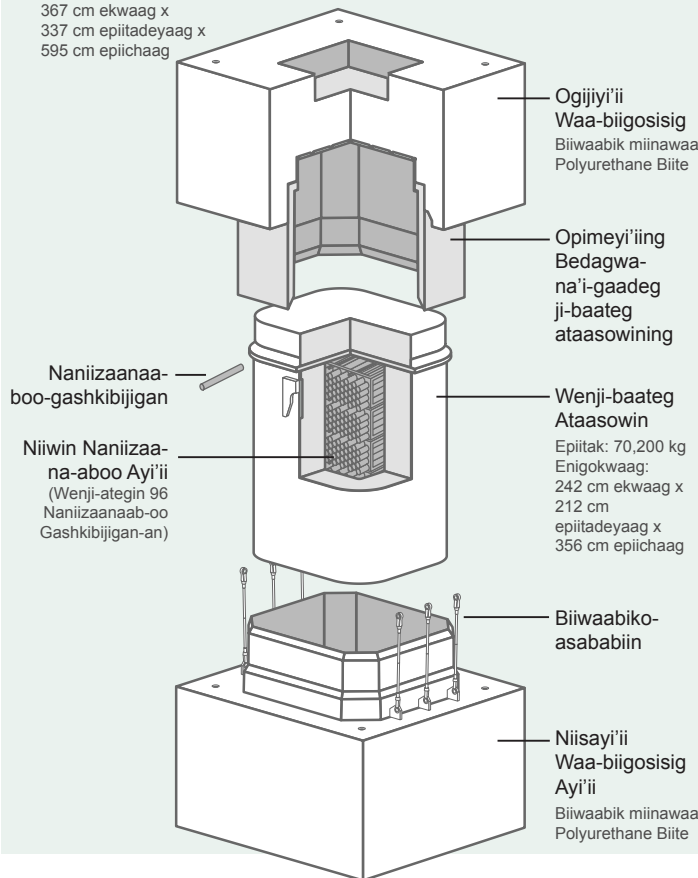

Wenji-baateg Ataasowin Bimibizonitoong Gashkibijigan

Gaa-aabajitoong naniizaanaaboo atasowin memeshkwad wenji-baateg atasowining (DSC) imaa Ontario Waasamowinikewin Webinigewin Gashkitoong Waakaa'iganan. DSC-TP aawang ateg DSC waa-biigosisigin ayi'in eyiidawayi'ing ategin.

DSC aawang ate wiyaw miinawaa giba'igan gaa-ozhichigaadegin meshkawaag asiniikaan gaa-aabajitoong miinawaa giiwitaayi'ii iw biiwaabik dibishkoo ozhaga'ayan. DSC wiyaw miinawaa giba'igan gii-dagwaabikizaming ji-badagwana'igaadegin ishkwaa-mooshkinebiig wiyawing naniizaanaaboo. Waa-aabajitoong miinawaa ayi'in aawanoon gaa-ozhichigaadegin gaa-aabajitoong biiwaabik-esag mooshkinegin biinjii'ing iw zetawegak polyurethane bite. Waa-biigosisigin ayi'in maamawi atewan aabajitoong biiwaabiko-asababiin. DSC wenji-ateg ji-badagwana'igaadeg weweni, miinawaa waa-biigosisigin ayi'in gaa-izhi-ozhichigaadegin ji-ganawenjigaadeg iw DSC giishpin bichi-doodaming. DSC gashkiwidoonan 384 gaa-aabajitoong naniizaanaaboo-gashkibijiganan miinawaa DSC ganabaj 100 tonnes epiitinigozid apii gii-boozitoong.

UFTP miinawaa DSC-TP gaa-izhi-ozhichigaadegin, gaa-goji-gikendaming miinawaa gaa-ganabendaming ji-ishkonaming gegoo biinjii'iing apii anokiimagak giishpin bichi-doodaming.

CNSC aabajitoonan niswi ezhichigewinan ji-bimibizonitoong weweni ganawendaming iw gaa-aabajitoong naniizaanaaboo.

1. CNSC miigiwen mazina'igaans ishkwa-izhi-ozhichigaadenig.
2. CNSC boozibii'amawaan waa-aabajitoonijin gashkibijiganini.
3. CNSC miigiwen mazina'igaans ji-bimibizonitoong.

Iw mazina'igaans gaa-izhi-ozhichigaadeg gashkibijigan ji-nandagikendaming anooj waa-ayaaming, gaye ji-izhinoo'aming waa-biigosisig bichi-doodaming ji-biigoshkaasig. Akawaabanchigewinan (Gashkibijigeng miinawaa Bimibizonitoong Naniizaanaaboo Ayi'iin Akawaabanchigewinan miinawaa Mizivekamig Atomic Waasamowin Enokijig (IAEA) Akawaabanchigewinan Ji-Bimibizonitoong Weweni Neniizaanak Waasamowin) baginigaade gikendaasoo-makakoong, diba'aming enigokwaag gemaa gaye naasaab enigokwaag goji-gikenjigaade ji-izhinoo'aming bimibizonitoong gashkibijigan onizhishing ji-ganabendaming. Maamawi deba'aming enigokwaag miinawaa goji-gikendaming gikendaasoo-makakoong gaa-onji-aabajitoong UFTP miinawaa DSC-TP.

Waa-gikendaming eshkam waa-onji-izhiwebak iw bimibizonitoowin gashkibijigan gaa-izhi-ozhichigaadeg, netamisingin niizh goji-gikendamowinan ozhibii'igaadewan omaa anaamiyi'ing bebezhiig ezhiwebakin giishpin daa-biigosing gashkibijigan, mii dash baamaa goji-gikendaming epiichi-gizhideg.

Bangising Goji-gikendamowin

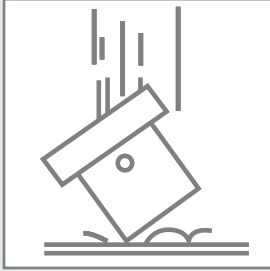

Gashkibijigan onji-bangisin Zhaangaso-diba'igan gii-ishpaag (30 zid) imaa wenji-nabagaag, gechi-mashkawaag (dibishkoo biiwaabiko-asiniikaan michisag), izhi-bakitesing ji-goji-biigosing.

Maanda goji-gikendamowin ezhichigeng ji-gikendaming ezhi-ayaag gashkibijigan apii gichi-bakitesing dibishkoo bimibizonitoong gichi-bakitesing. Bengisingin aabajitoong goji-gikendaming awashime gechi-bangisingin dash wiin bangisininig ishkode-odaabaaning apiichibizod 160 km/h bakitesininig iw bimibizonitoowin gashkibijigan. Gikenjigewin ozhibii'igaade imaa NWMO wiindamaagewining: Goji-gikendamowin Zhaangaso-diba'igan Wenji-bakitesing dibishkoo gegaa gakina gegoo bichi-doodaming (NWMO TR-2014-04).

Wii-bagoneyaag Goji-gikendamowin

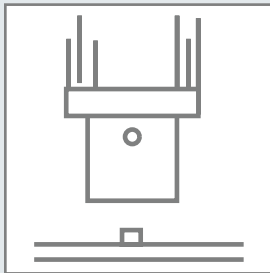

Ishkwaa-bakitesing, naasaab gashkibijigan onji-bakitesing ningo-diba'igan ishpaag (40-ninj) bakitesing imaa 15-diba'igaans (6-ninj) naawiyi'ii biiwabik gibaakwa'igan 20 diba'igaans ekwaag (8-ninj) ekwaag.

Bangising goji-gikendamowin dibishkoo bakitesing wenji-dawaag, maanda goji-gikendamowin ji-ganawaabandaming giishpin wenji-bakitesing imaa bajiiishkaag. Goji-gikendamowin ji-bagoneyaasig gashkibijiganing.

Gizhideg Goji-gikendamowin

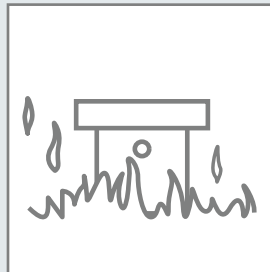

Naasaab gashkibijigan gaa-aabajitoong azhigwa gii-goji-gikendaming achigaade gichi-ishkodeng. Iw ishkode daa-apiichi-gizhide 800 degrees Celsius (1,475 degrees Fahrenheit) 30 diba'igaans daso-diba'iganeg.

Maanda goji-gikendamowin dibishkoo bachi-doodaming naniizaanaaboo zakideg besho gashkibijiganing. Gashkibijigan gakina daa-ate ishkodeng daso-diba'iganeg goji-gikendaming. Ishkode daa-apiichi-gizhide 800 degrees Celsius, ko hydrocarbon ishkode aawan. Geget bichi-doodaming, ishkodeng ategin ishkodeyaaboon gaawin zakidesinon ko 30 diba'igaans daso-diba'iganeg ishkodeyaaboo eshkam bangii miinawaa ishkode mamaajseg.

Nibiing Goji-gikendamowin

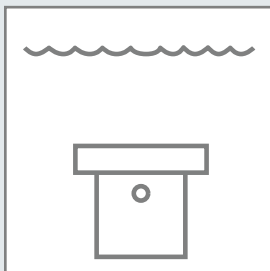

Aabajitoong gikendaasoo-makak gikenjigewin gemaa gaye zhiibinemagak goji-gikendamowinan, iw gashkibijigan goji-gikendaming dibishkoo 15 diba'igan apiichi-ishpiindimaag (50 zid) nibiing biinish 8 diba'igan daso-diba'iganeg giishpin wii-onjigaag. Iw gashkibijigan achigaade nibiing gaye goji-gikendaming 200 diba'igan apiichi-ishpiindimaag (650 zid) ji-goji-gikendaming giishpin gichi-ishpiindimaag.

Nibiin besho aazhooganing ko, miikanaang, gemaa gaye wiikwedong ganabaji bangii wiin epiichi-ishpiindimaag 15 diba'igan. Nishwaaso-daso-diba'iganeg ji-izhiwebak gashkibijigan ji-izhi-ayaag naasaab, aanawi wegodogwen daso-diba'iganeg wii-maajidoong. Nibiing gichi-goji-gikendamowin (200 diba'igan) inendaagwad giishpin gashkibijigan gozaabiig wenji-dimiig, dibishkoo neyaashing imaa continental shelf. Agwanjitoong gashkibijigan wenji-gichi-dimiig.

Izhinoo'amaageng Goji-gikendamowinan Bijiinag Daso-gikinoonowinagak

Awashime izhichigeng wiin goji-gikendaming ko, daso-gikinoonowinagak, gaa-aabajitoong naniizaanaaboo bimibizonitoong gashkibijiganan naasaab goji-gikendaming dibishkoo UFTP miinawaa DSC-TP achigaadewan gashkibijiganan wenji-gichi-goji-gikendaming izhinoo'amaageng.

Dibishkoo maanda:

- » Bezhig aawan, gichi-goji-gikendamowin onizhishiwaad ishkode-odaabaanag 1984 gii-izhichigewag United Kingdom's Naawiyi'ii Waasamowin Enanokijig izhinoo'amowaad gashkibijigan gii-izhi-ozhichigaadenig ji-goji-gikendaming IAEA waa-ayaaming daa-biigosisininig bitaakoshkang ishkode-odaabaan apiichi-gizhiibizod 160 km/h.



- » Apii 1999, German Federal Institute Ayi'iin Nandagikenjigewin miinawaa Goji-gikendamowinan gii-baashkizod propane ishkode-odaabaan mooshki-nebiid besho naniizaanaaboo webinige-win bimibizonitoowin atoobaan. Aw Bayaashkizod ishkode-odaabaan gii-bitaa-koshkaan iw atoobaan, gii-booniimagadini imaa epiichaag 10 diba'igan imaa akiing bangii anaamikamig. Ayi'ii bliinjyi'iing geyaabi gii-badagwana'igaadewan mii eta agwajyi'iing gashkibijiganing gii-onji-ojiishiging.



Gakina goji-gikendamowinan, iniw bimibizonitoowini-gashkibijiganan gii-mino-ayaawan gii-onjigaasinoog ishkwa-izhinoo'amaageng.

Geyaabi NWMO Ezhichigewinan

NWMO geyaabi da-goji-gikendaming ezhi-ayaag gashkibijigan anooj izhiwebakin miinawaa da-nandagikendaming maajishkaamagakin gikenjigewinan ji-mino-ozhichigaadeg gashkibijigan ji-mino-ayaag.

8 Gashkitoong Neniizaanakin

Naniizaanaaboo Webinigewin Geshkitoojig (NWMO) daa-izhinoo'aanaawaa onji-bimibizonitoong gaa-aabajitoong naniizaanaaboo imaa atasowigamigoon atenig memeshkwad biinish iwidi gabeyi'ii da-atenig naniizaanaaboo atasowigamigoong wii-mino-ayaanig miinawaa bemaadiziniin miinawaa ezhiwebadinig agwajiing ji-ganawenjigaazoniin miinawaa ji-ganawendaming apane go.

Neniizaanak Waasamowin mikaming niibina ezhi-ayaag. Bemaadizijig ayaawaad waasamowining wenji-atenig akiing endaso-giizhig, waakaa'iganing ayi'iin, noodininig, miijiming, ishpiming giizhigoong (cosmic waazakonegin), miinawaa ayi'ii izhiwebadinig wi yawing.

Minik neniizaanadinig waasamowin bemaadizid wenji-ayaad iko ezhinikaadenig bagwaji-waasamowini-ayaawin. Canadian Naniizaanaaboo Ayaangwaamiziwin Enokiiijig (CNSC) *Naniizaanaaboo-waasamowin Ganawenjigewin Akawaabanchigewinan* hgiizhichigeng waasamowin-ayaawin endaso-gikinoonowin 1 milliSievert (mSv) bemaadizijig ji-ayaawaad bangii besho naniizaanaaboo wenji-izhichigeng. Maanda waasamowin-ayaawin gegaa aabita wiin iw bagwaji-waasamowin-ayaawin odaapinamowaad Canadians (1.8 mSv endaso-gikinoonowin).

CNSC *Naniizaanaaboo-waasamowin*

Ganawenjigewin Akawaabanchigewinan miinawaa wii-izhichigem ganawaabandaming apiichi-ayaanig waasamowin-ayaawin ayaawaad naniizaanaaboo waasamowin enanokiiijig. Onow akawaabanchigewinan onji-ozhitoong apiichi-ayaag waasamowin-ayaawin 50 mSv endaso-gikinoonowin miinawaa gichi-niibina 100 mSv naano-gikinoonowinagak.

CNSC aabajitoong inaapinewin nandagikenjigewinan miinawaa miziwekamig nisidotaming iw neniizaanak waasamowin ji-ozhitoong weweni wenzhishininig akawaabanchigewinan ji-ganawenimindwaa weweni Canadians. CNSC miinawaa bekaanizijig ekawaabanchigejig ozhitoonaawaa epiichi-ayaanig naniizaanadinig waasamowin. Mii maanda adoopowin izhibii"igaadeg epiichi-waasamowin-ayaag miinawaa inaapinewinan apiichi-ayaag neniizaanak waasamowin.

Wegonen mSv?

Iw milliSievert eko-midaaswaak bliinjyi'ii iw Sievert, diba'igan aawan waasamowin-ayaawining waabanchigaade waa-onji-izhiwebizing anooj ategin dinowa waasamowin-ayaawinan.

Waasamowin-ayaawin	Apiich gemaa gaye Izhi-ayaawin
Awashime wiin 5,000 mSv	Waasamowin-ayaawin wii-onji-nibom giishpin gakina
1,000 mSv	Waasamowin-ayaawin wii-onji-ozhitoong waasamowinaapinewin (e.g. ayekoziwin miinawaa maazhide'ewin) giishpin odaapinigaadeg 24 daso-diba'ganeg
100 mSv	Bangiishens waasamowin-ayaawin waa-onji-ozhichigaadeg agomowaapinewin
30–100 mSv	RWaasamowin-ayaawin gakina wi yaw nanagikenjigaadeg gikendaasoo-makakoong mazinaakizon (CAT)
50 mSv	Endaso-gikinoonowin waasamowin-ayaawin apiich wenji-ayaawaad naniizaanaaboo-waasamowin enanokiiijig
1.8 mSv	Mayena endaso-gikinoonowin Canadian bagwaji-waasamowin-ayaawin
1 mSv	Endaso-gikinoonowin bemaadizijig apiich waasamowin-ayaawin
0.1–0.12 mSv	Waasamowin-ayaawin opan gaa-zhaabwaatesidoong
0.01 mSv	Waasamowin-ayaawin owiibidan gaa-zhaabwaatesidoong
0.01 mSv	Mayena endaso-gikinoonowin waasamowin-ayaawin ishpiming babaamaadizing

Wenjibaamagak: CNSC waasamoo-asab – Neniizaanak Waasamowin Izhi-ayaawinan
www.nuclearsafety.gc.ca/eng/resources/radiation/introduction-to-radiation/radiation-health-effects.cfm

Waasamowin-ayaawin ayaawaad Bemaadizijig bimibizonitoong

Jibwaa-bimibizonitoong iw gaa-aabajitoong naniizaanaaboo bagidenindamaagewaad ekawaabanchigejig iw Gaa-aabajitoong Naniizaanaaboo Bimibizonitoong Gashkibijigan (UFTP) gemaa gaye Wenji-baateg Atasowin Bimibizonitoong Gashkibijigan, NWMO daa-izhinoo'amawaawaan iniw bemaadiziniin giishpin ayaang wenji-naniizaanak waasamowin-ayaawining wenji-bimibizonitoong iw bangiishens anaamiyi'ing apiich (1 mSv endaso-gikinoonowin).

Inendaming iw endaso-gikinoonowin minik bimibizonitoowinan inaakonigeng miinawaa noongom ezhi-onji-ozhichigaadeg imaa UFTP, giishpin ayaawaad bemaadizijig waasamowin-ayaawining wenji-bimibizonitoong bagosendaming awashime bangii wiin akawaabanchigewin apiich.

Bijiinag nandagikendaming gii-izhichigem ji-gikendaming giishpin waasamowin-ayaawining ayaawaad bemaadizijig wenji-bimibizonitoong aabajitoong UFTP. Nandagikendaming onaabanchigaazowaad bemaadizijig endanakiijig besho wenji-bimibizonitoong, bemaadizijig maada'ookiwaad wenji-bimibizonitoong, miinawaa bemaadizijig wenji-anwebing wenji-bimibizonitoong. Iw waasamowin-ayaawin endaso-gikinoonowin ayaawaad bemaadizijig bagosendaming awashime bangii wiin iw akawaabanchigewin bemaadizijig waasamowin-ayaawin weyekwaayaanig.



Waasamowin-ayaawining ayaawaad Bimibizonitoowin Endazhiikangig

Wenji-dazhiikaming iw bemaadizijig waasamowin-ayaawin gekendaming, iw bakaan nendagikendaming gaa-onji-gikenjigaadeg wii-izhi-ayaag waasamowin-ayaawin anokiing bimibizonitoowin endazhiikaming aabajitoong iw gaa-aabajitoong naniizaanaaboo bimibizonitoong aabajitoong iw UFTP.

Bimibizonitoong izhichigewinan gii-ganawaabanchigaadewan gii-nandagikendaming memindage go enokiing izhichigewinan apii gaa-aabajitoong naniizaanaaboo gashkibijigan maajaamagak imaa memeshkwad wenji-ateg atasoowigamigoong biinish dagwising imaa bakaan wenji-ataasong. Iw nandagikenjigewin gii-waabanjigaadeni waasamowin-ayaawining ayaawaad enokiijig wii-aawanini awashime bangii iw waasamowin-ayaawin wiin iw ekawaabanchigaadenig bemaadizijig waasamowin-ayaawin weyekwaayaanig 1 mSv endaso-gikinoonowin.

9 Bemibizonitoong Onji-akawaabanchigeng

Biinjyi'iing Canada, ayaangwaamizing, weweni mamaajisenig naniizaanaaboo waasamowin ayi'iin niizh maamawi akawaabandamowaad igiw Canadian Naniizaanaaboo Ayaangwaamiziwin Enokiijig (CNSC) miinawaa Bimibizonitoowin Canada.



CNSC akawaabandaanaawaa bimibizonitoong naniizaanaaboo-waasamowin ayi'ii imaa *Gashkibijigeng miinawaa Bimibizonitoong Naniizaanaaboo Ayi'iin Akawaabanchigewinan (PTNSR)*.

PTNSR wenji-ategin iniw ayaangwaamiziwin akawaabanchigewin waa-ayaaming aabajitoong apane go megwaa bimibizonitoong, apii gii-maajii-gashkibijigeng biinish bagamigaadeg. Akawaabanchigewin gashkibijigeng miinawaa bimibizonitoong gaa-aabajitoong naniizaanaaboo wenji-gashkitoong:

- » Ozhitoong bimibizonitoowin gashkibijigan ezhi-ayaag waa-ayaaming;
- » Goji-gikendaming bimibizonitoowin gashkibijigan ezhi-ozhitoong;
- » Onji-ozhibii'igeng ayaabajitoojig iw gaa-ganawaabandaming bimibizonitoowin gashkibijigan;
- » Ozhisidoong miinawaa baapish iw naniizaanaaboo-waasamowin ganawaabandaming izhichigewin waa-bimibizonitoojig;
- » Miigiweng iw Mazina'igaans Ji-bimibizonitoong iw gaa-aabajitoong naniizaanaaboo apii eta iw Wewiib Naadamaagewin Inaakonigewin miinawaa Bimibizonitoowin Ganawaabanchigewin Inaakonigewin gii-ozhisidoong miinawaa gii-ganabandaming;
- » Achigaazowag Ekawaabanchigejig 24-7 giishpin gegoo waa-izhiwebadinig;
- » Nandagikenjigeng weweni giishpin gegoo waa-izhiwebak wii-bi-naadamaageng;
- » Akawaabandaming gakina gegoo izhichigewinan ganawaabanchigeng; miinawaa
- » Izhichigeng waa-ayaaming nandagikendaming.

Jibwaa-bimibizonitoong iw gaa-aabajitoong naniizaanaaboo Canada, CNSC's waa-nisidotaming akawaabanchigewin anokiiwin waa-onji-ayaaming iw bimibizonitoowini-mazina'igaans gashkibijigan miinawaa mazina'igaans ji-bimibizonitoong. CNSC goji-gikendaming waa-bimizonitoong mazina'iganan ji-izhichigeng ayaangwaamiziwin miinawaa ganawaabanchigewin onizhishingin aapiji, gakina gegoo waa-ayaaming ji-gikendaming, miinawaa ji-atenig wenzhishininig ayaangwaamiziwinan ji-ganawenchigaazowaad bemaadzijig miinawaa ji-ganawendaming aki. Ayi'iin bimibizonitoong izhichigewin gaa-dazhindaming omaa goji-gikendamowining:

- » Gikinoo'amaagoziwaad enokiijig miinawaa wewiib nayaadamaagejig;
- » Ganawendaming iw naniizaanaaboo-waasamowin ganawaabanchigewin izhichigewin;
- » Gashkitoong iw wewiib naadamaagewin inaakonigewin;
- » Ganawendaming iw ganawaabanchigewin izhichigewinan;
- » Ganawendaming iniw gaa-ozhibii'igeng mazina'iganan; miinawaa
- » Bizindaming weweni igiw gakina akawaabanchigewinan waa-ayaaming.

CNSC debwewini-mazina'igan ezhinikaadeg *Akawaabanchigeng Gashkibijigeng miinawaa Bimibizonitoong Naniizaanaaboo Ayi'iin biinjyi'iing Canada ate imaa www.nuclearsafety.gc.ca.*

CNSC gaye miigiwem gagwedwewinan wii-gikendaming iw bimibizonitoong gaa-aabajitoong naniizaanaaboo imaa waasamoo-asabiig gikendaasoo-makakoong.



PTNSR onjibaamagadini imaa gikinoowaabanjiganing gaa-ozhibii'amowaad Miziwekamig Atomic Waasamowin Enanokijig (IAEA). Awashime wiindamaagewin ate IAEA imaa www.iaea.org.



Bimibizonitoowin Canada's *Bimibizonitoong Neniizaanakin Gashkibijiganan Akawaabanchigewinan ji-onji-ozhitoong waa-ayaaming wii-onji-gikinoo'amaageng, wewiib naadamaagewin inaakonigeng, ayaangwaamiziwin gika'iganan, miinawaa ozhibii'igewin.*

Bimibizonitoowin Canada's inendamaagoziwinan ji-bimibizonitoong naniizaanaaboo-waasamowin ayi'iin onow:

- » Ozhisidoong miinawaa baapish bimibizonitoong waa-onji-ayaaming igiw enina-maagejig miinawaa bemibizonitoojig;
- » Ozhisidoong waa-ayaaming miinawaa ezhichigeng booch nandagikenjigewinan apii gikinoo'amaageng miinawaa ozhibii'igeng; miinawaa
- » Ozhisidoong miinawaa baapish waa-ayaaming ji-naadamaageng wewiib inaakonigewinan.

Bimibizonitoowin Canada's Canadian Bimibizonitoowin Naadamaagewinigamig (CANUTEC) aawan Canada wiindamaagewin ji-wiidookaageng naadamaageng dazhiikaming neniizaanakin ayi'iin wewiib naadamaageng 24-7. Iw naadamaagewinigamig endanakijig imaa gekendaasojig endazhiikangig izhi-ayaakewin gemaa gaye naasaab izhichigewin miinawaa gii-gikinoo'amaagozing ji-naadamaageng wewiib. Igiw naadamaagewin gekendangig netaa-aanikanootamowaad gikendaasowin wiindamaagewin wenjibaamagadinig anooj ningoji gaye imaa Ayi'ii Ayaangwaamiziwin Gikenjigewin Mazina'iganan (MSDS) ji-miigiweng nibwaakaawin minopii.

Bimibizonitoowin Canada's akawaabanchigewinan ji-bimibizonitoong iniw neniizaanakin ayi'iin onji-aabajitoong gii-inaakonigeng provincial miinawaa territorial.



Provincial ogimaawiwinan/akawaabanchigewinan/enokijig inendamaagoziwag ji-izhichigeng booch baapish provincial inaakonigewinan miinawaa nandagikenjigewin, gemaa gaye onji-izhichigeng bimibizonitoong enakamigak ategin naniizaanaaboo-waasamowin ayi'ii.

Akawaabanchigewin Izhichigewin



Transport Canada / Transports Canada



Canadian Nuclear Safety Commission / Commission canadienne de surete nucleaire

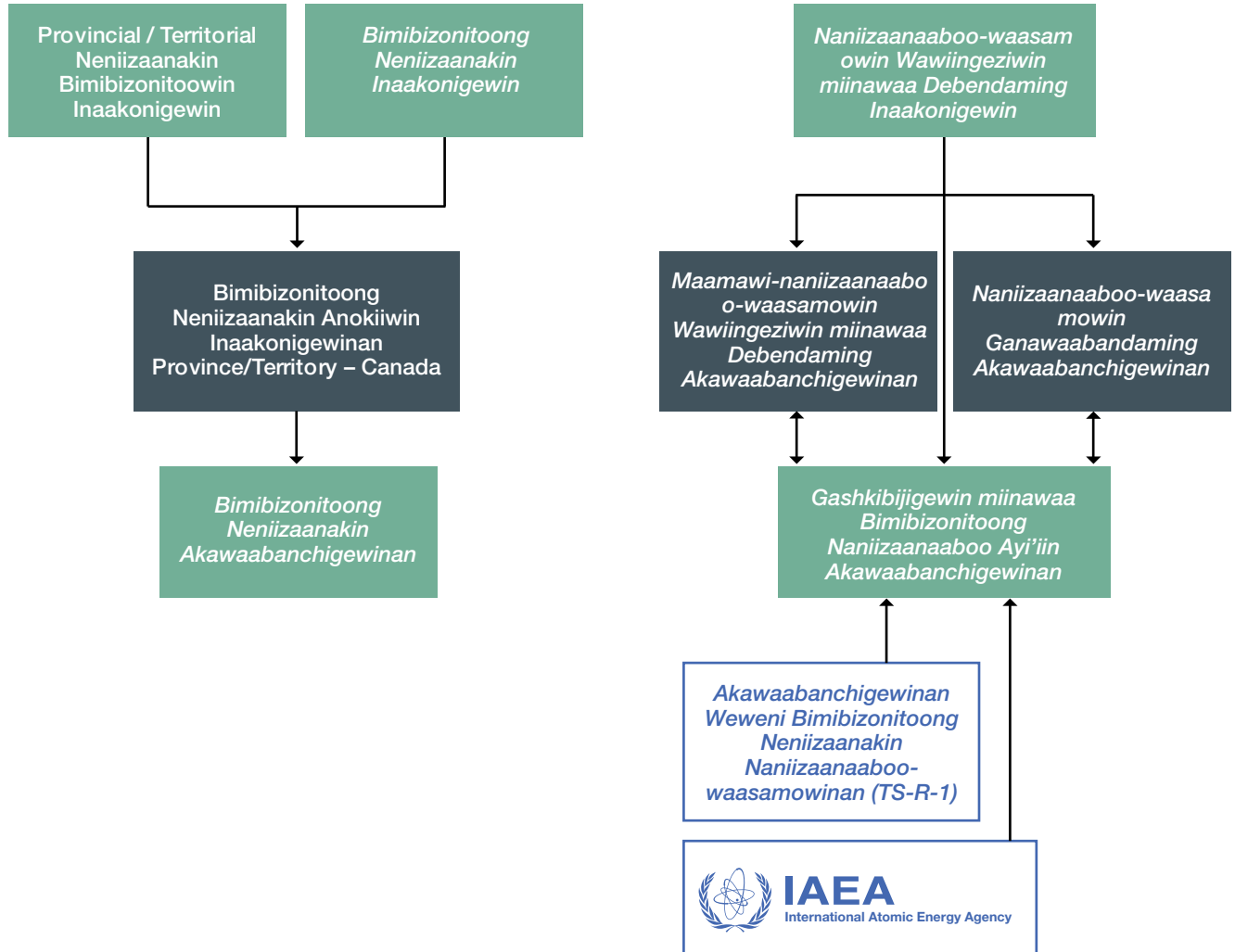

10 NWMO Inanokiiwinan miinawaa Inendamaagoziwinan

Naniizaanaaboo Webinigewin Geshkitoojig (NWMO) gichi-inendamaagoziwag ji-bimibizonitoong weweni iw gaa-aabajitoong naniizaanaaboo imaa noongom memeshkwad wenji-ataasong biinish imaa gichi-anaamikiing wenji-ataasong. Canadian Naniizaanaaboo Ayaangwaamiziwin Enanokiiig (CNSC) miinawaa Bimibizonitoowin Canada inendamaagoziwag ji-izhichigeng weweni iniw akawaabanchigewinan.



Ganoonidiwin

NWMO da-dazhiikaanaawaa naawiyi'ii ogimaa-gamig ji-onji-ganoonidiwaad igiw gakina enokiiig bimibizonitoong onji-ganooniding. Ogimaa-gamig ji-onji-odaapinaming wewiib iw bimibizonitoowin gikenjigewin, miinawaa wenji-odaabii'iweng, ezhiwebak, bimibizong, miinawaa waa-onji-bimibizonitoong, miinawaa wii-onji-ganooniding gaye wedaabii'iwed, genawaabanchigejig, miinawaa giishpin waa-ayaaming, ekawaabanchigejig miinawaa nayaadamaagejig, miinawaa Bimibizonitoowin Canada, CANUTEC (Bimibizonitoowin Canada's Canadian Bimibizonitoowin Wewiib Naadamaagewini-gamig) miinawaa CNSC.

Ganoonidiwin da-ate megwaa bimibizonitoong iw gaa-aabajitoong naniizaanaaboo noopinadoong iw Bimibizonitoowin Ganawaabanchigewin Inaakonigewin. Miinawaa wenji-ganooniding onow:

- » Bimibizonitoowin Ogimaa-gamig;
- » Genawaabanchiged ayaa wenji-bimibizonitoong iw gaa-aabajitoong naniizaanaaboo;
- » Wenji-ataasong gaa-onji-bimibizonitoong gashkibijigan;
- » Wenji-ataasong; miinawaa
- » Gakina wewiib naadamaagewin ogimaa-gamigoon etegin provinces waa-onji-bimibizonitoong gashkibijiganan.

Giishpin bichi-doodaming, bimibizonitoowin ogimaa-gamigoong da-onji-wiindamaageng. Apii wiindamaageng, aw bimibizonitoowin ogimaa-enokiid da-onji-wiindamaaged imaa wewiib naadamaagewin ogimaa-gamigoong province gaa-onji-bichi-doodaming. Provincial wewiib naadamaagewin ogimaa-gamigoon waa-onji-ganooniding gaye nayaadamaagejig miikanaang wenji-bimibizonitoong.



Wewiib Naadamaagewin

NWMO da-miinaawaan wewiib naadamaagewin inaakonigewin CNSC, Bimibizonitoowin Canada miinawaa provinces, onji-nitaawichigem ji-gikendaming gwayak wiindamaagewin miinawaa waa-babaa-ayaaming wii-aabajitoowaad nayaadamaagejig. NWMO wii-wiidookawaawaan nayaadamaagenijin wii-ozhitoonijin naadamaagewinini inaakonigewinini dazhiikaanijin gaa-aabaajitoong naniizaanaabooni, daa-izhichigeng.

Wenji-ateg naadamaagewin inaakonigewin ji-anokiitaading weweni NWMO, provincial miinawaa besho nayaadamaagejig, ogimaag odenaang, miinawaa federal enokijig. Wenji-gikendaming iw Wewiib Naadamaagewin Gashkitoowin Anokiwin Canada (2nd mazina'igan – Manidoo-giizis 2011), gakina ningoji ogimaawigamigoong wenji-anokiing waa-onji-gagwedweng ji-izhichigeng wii-naadamaageng wii-gashkitoong. Provincial ogimaawiwinan miinawaa wenji-dazhiikaming miinawaa wenji-ganawaabachigeng da-onji-inendamaagozing ji-naadamaageng izhichigewinan. Federal anokiwinan ji-onji-miigiweng awashime gegoo waa-ayaaming onji-gagwedweng province/oodena.

Maamawi provinces, NWMO weweni da-izhichigewag inaakonigewaad, miigiwewaad gaa-aabajitoong naniizaanaaboo izhi-gikinoo'amaagewin, miinawaa gegoo ji-gagwejjichigeng wenji-bimibizonitoong. Gagwejjichigewinan ji-onji-gikinoo'amaageng, weweni wii-ganooniding, miinawaa wii-inaakonigeng, miinawaa wii-nitaawichigeng awashime, wewiib naadamaagewin izhichigewinan. Gagwejjichigewinan gakina wii-izhichigeng, miinawaa adoopowining gagwejjichigewinan, ji-goji-gikendaming iw ezhi-izhichigeng iw izhichigewin. Inendaming ji-gichi-ayaangwaamizing bimibizonitoong gegoo inakamigak, NWMO da-izhichigewag gichi-ozhiitaang wii-naadamaageng gaye naadamaagewin inaakonigewinan miinawaa izhichigewinan gechi-goji-gikendaming apii memeshkwad gikinoo'amaageng, inanokiwin ganooniding, miinawaa maajiishkaawin miinawaa maamawi gagwejjichigeng.

Biinjiyi'ing Canada, wewiibitaawin naadamaagewin geshkitoojig gii-odaapinaanaawaa gakina neniizaanadinig onji-izhichigeng wii-gichi-doodaming wii-gichi-maji-izhiwebadinig, maanoo onji-izhiwebadinig. Federal, provincial miinawaa besho ogimaawiwinsan gii-onji-odaapinaming nesidotaming ezhichigewin wii-gashkitoong wewiib naadamaagewin, gaye naasaab ezhichigeng netaawichigeng jibwaa-maji-izhiwebak, ezhichigeng wii-naniizaanak eshkam bangii,ozhiitaawin, naadamaagewin miinawaa nanaa'itowin ezhichigeng. NWMO da-anokiwwag maamawi provincial miinawaa besho ogimaawiwinsan ji-gikinoo'amaageng weweni wii-atenig aabajichiganan waa-aabajitoong wii-maawanji'idiwaad nayaadamaagejig waa-ayaaming gikinooowaabanjiganan wenji-bimibizonitoong. NWMO da-noopinadoonaawaa maanda izhichigewin inaakonigeng miinawaa ozhiitaang wenji-bimibizonitoong iw gaa-aabajitoong naniizaanaaboo.



Ganawaabanchigewin Inendamowinan

NWMO inendamaagozi ozhitoong iw bimibizonitoong ganawaabanchigewin inakonigewin. Iw giizhendamowin inakonigeng ji-ganawendaming iw gaa-aabajitoong naniizaanaaboo weweni giishpin anooji gegoo naniizaanak bimibizonitoong. Neniizaanakin ge-gaganawaabandaming ji-apiichi-naniizaanazinoog weweni izhiwebakin.

Apiichi-ganawaabanchigewinan inagakeyi'in ji-ganawendaming weweni bimibizonitoong giishpin wii-maji-doodaming iw gashkibijigan, miinawaa izhitoowinan, ezhi-ayaag miinawaa epiichi-ganawaabandaming ji-ganawendaming iw gashkibijigan, miinawaa ji-gikendaming, ji-madwesing, ji-zagakibii'aming, miinawaa ji-ganooniding, giishpin gegoo ezhiwebak. Ganawaabanchigewin izhichigewinan bimibizonitoong gii-izhi-ozhichigaadewan ji-ganawendaming weweni gaa-aabajitoong naniizaanaaboo memindage go apii naniizaanak gegoo miinawaa naasaab inakonigeng Bakibii'igan 5 Naniizaanaaboo Ganawaabanchigewin Akawaabanchigewinan mazina'iganing gaa-miigiweng CNSC.

Bimibizonitoowin Ganawaabanchigewin Akawaabanchigewin Inakonigewinan wii-ganawendaming ji-oshki-izhiwebakin miinawaa wii-agindaming miinawaa aayaapii CNSC ji-gikendaming ji-dazhindaming epiichi-naniizaanakin.

CNSC akawaabanchigewinan waa-ayaaming iniw ganawaabanchigewinan daa-dazhindaming wii-bimibizonitoong gaa-aabajitoong naniizaanaaboo, gaye:

- » Bimibizonitoowinan daa-onji-ayaa genawaabandang miinawaa daa-onji-ganawaabanchigaadeni apane;
- » Bimibizonitoowin Ganawaabanchigewin Inakonigewin wenji-bimibizonitoong gaa-aabajitoong naniizaanaaboo daa-achigaade ogimaa-gamigoong;
- » Ganawaabanchigewinan dibishkoo bemi'iwejjig, ganoonidiwin inakonigewinan ji-ganooniding ganawaabanchigeng, ayaangwaamiziwin nandawaabanchigeng jibwaa-bimibizonitoong, giishpin gegoo waa-izhiwebak onji-izhichigewinan giishpin ondami'iweng gemaa gaye gegoo biigoshkaag, miinawaa izhichigewinan daa-izhichigeng nagaabizong gemaa gaye namanj apii ondami'iweng daa-ayaaming gaye;
- » Ayaangwaamizing, neniizaanak miinawaa bechi-doodaming goji-gikendamowin daa-izhichigewag netaawichigejjig miinawaa giimooj enokiijig ji-mikamowaad waa-naniizaanadinig gegoo miinawaa daa-onji-onizhishininig awashime, gaye daa-izhichigem ji-naniizaanak eshkam bangii, miinawaa daa-waabanchigaade gakina gegoo neniizaanak; miinawaa
- » CNSC gii-miigiwen gikenjigewin iw wiindamaagewin ji-akawaabandaming ji-bimibizonitoong weweni. Gakina wiindamaagewin onji-akawaabanchigeng miinawaa izhichigeng maanda dinowa bimibizonitoowin inendamoring giimooj wiindamaagewin miinawaa gaawiin awiya daa-gikendaziin. Bagidinigaadenig wiindamaagewin daa-miinaawag bemaadizijig gemaa gaye enokiijig giishpin booch daa-gikendamowaad, dibishkoo dakoniwewininiwag.

11 Gakina Ningoji Gaa-dazhi-anokiingiban

Miziwekamig Endanakijig ozhitoonaawaa inaakonigewinan ji-izhichigeng izhichigewinan ji-gashkitoong gabeyi'ii gaa-aabajitoong naniizaanaaboo gemaa gaye naniizaanaaboo-waasamowin ayi'iin. Gii-gichi-izhichigebaniig weweni gii-bimibizonitoowaad, Canada miinawaa gakina ningoji.

Naanimidana biboonagak, miziwekamig miinawaa Canada, gaawiin awiya gii-godigoshinsii, gii-aakozisii, gii-nibosii gemaa gaye gii-maji-izhiwebazinoon agwajjig gii-atesininig gii-izhi-ayaag gaa-aabajitoong naniizaanaaboo gii-bimibizonitoong.

Ogimaawiwinan, akawaabanchigewinan miinawaa zhooniyaakewinan Canada miinawaa miziwekamig gaa-gichi-izhichigewaad weweni, bimibizonitoowaad iw naniizaanaaboo-waasamowin ayi'iin. Canada bimibizonitoonan midaaswaak-sagoons iidog gashkibijiganan endaso-gikinoonowin naniizaanaaboo-waasamowin ayi'iin. 1970s biinish noongom, Canada gii-bimibizonitoonan naanan iidog gaa-aabajitoong naniizaanaaboo gashkibijiganan endaso-gikinoonowin imaa naniizaanaabookewigamigoong izhiwidoong Atomic Waasamowinikewigamigoong Canada Limited's Chalk Ziibi Gikenjigewi-gamigoon ji-nandagikendaming miinawaa ishkwaagidiskinaming akawaabandaming.

Miziwekamig Atomic Waasamowin Dezhiikangig, Ogimaawiwinan Dezhiikangig, miinawaa netaawichigejig gakina ningoji, memindage go United States, United Kingdom, Europe, miinawaa Japan, ganawaabandamowaad ayaangwaamiziwinan megwaa naniizaanaaboo ayi'iin bimibizonitoong.

Biinjyi'ing United States, gegaa 3,000 bimibizonitoowinan gaa-aabajitoong naniizaanaaboo gii-achigaadewan 2.5 midaaswaak dasing midaaswaak ganabaj gaye awashimee niimidana gaa-daso-gikinoonowinagak, memindage miikanaang miinawaa ishkode-odaabaani-miikanaang. United Kingdom miinawaa France bimibizonitoonaawaan ganabaj 550 gashkibijiganan gichi-naniizaanaaboo-webinigewin endaso-gikinoonowin, memindage ishkode-odaabaani-miikanaang. Sweden bimibizonitoonan ganabaj 40 gashkibijiganan endaso-gikinoonowin nibiikaang, megwaa Japan bimibizonitoonan ganabaj 200 gashkibijiganan nibiikaang.

Aki Naniizaanaaboo
Bimibizonitoowin Enokijig
Gaa-miigiwewaad



Minik lidog
Gashkibijiganan

Dinowa
Bimibizonitoowin

 Miikana

 Ishkode-odaa
baani-miikana

 Nibi

Canada

 Naanan Endaso-
gikinoonowin

United Kingdom

 Niswaak Endaso-
gikinoonowin

United States

   Nisosagoons
biinish noongom

France

 Niizhosagoons-ashi-
niizhdana-ashi-naanan

Mii Waabanda'aming
Gaa-izhichigeng
Gaa-bimibizonitoong
Weweni Gaa-aabajitooong
Naniizaanaaboo Canada
miinawaa Gakina Ningoji



Sweden



Niimidana Endasogikinoonowin

Germany



Niimidana Endasogikinoonowin

Japan



Niizhwaak biinish noongom

12 Aabajichigewinan

Naniizaanaaboo Wiindamaagewi-mazina'iganan, Wiindamaagewinan Gikendaasoo-makakoong miinawaa Mezinaatesegin

Naniizaanaaboo Webinigewin Geshkitoojig: www.nwmo.ca

- » Bimibizonitoong Canada Gaa-aabajitoong Onaniizaanaaboo
- » Atoong Ezhi-gashkichigeng Inagakeyi'iin
- » Ningoding eta wii-agindaman wiindamaagewin, mezinaatesegin, mazina'iganan miinawaa nawaj
- » Weweni Geshkitoong Gaa-aabajitoong Naniizaanaaboo Canada
- » Inaapinewin Nandagikenjigewin
- » Enokiid Inaapinewin Nandagiikenjigewin
- » Eko-nising Maajiishkaawin, Netamising Izhichigewin Jibwaa-maajitaang
Nandagikenjigewinan: Eko-ningodwaaching Agindaasowin – Jibwaa-maajitaang
Nandagikenjigewin Bimibizonitoong

Canada Neniizaanak Owaasamowin Ayaangwaamiziwin Endazhiikangig: www.nuclearsafety.gc.ca

- » Zhaabowaasamowin Izhi-ayaawinan
- » Akawaabandaming gashkibijigeng Bimibizonitoong Neniizaanak Waasamowin Ayi'iin Canada
- » Moozhag gagwedweng izhi-bimibizonitoong gaa-aabajitoong naniizaanaaboo
- » Gashkitoowin Gikino'amaagewin Bimibizonitoong Akawaabanchigewin Inaakonigewinan Epiichi-naniizaanak giishpin bezhig, niizh gemaa gaye niswi iw Neniizaanak Waasamowin (G-208)

Bimibizonitoowin Canada: www.tc.gc.ca

- » Ozhiitaawin giishpin gegoo wii-izhiwebak

Miziwekamig Atomic Waasamowin Anokiiwin: www.iaea.org

- » Bimibizonitoowin neniizaanak waasamowin

Aki Waasamowin Bimibizonitoowin Waakaa'igan: www.wnti.co.uk

Giishpin nawaj wiindamaagewin, ganoozh:

Naniizaanaaboo Webinigewin Geshkitoojig (NWMO)

22 St. Clair Avenue East, Sixth Floor

Toronto, Ontario M4T 2S3 Canada

Tel: 416.934.9814

Email: contactus@nwmo.ca

Website: www.nwmo.ca

nwmo

NUCLEAR WASTE
MANAGEMENT
ORGANIZATION

SOCIÉTÉ DE GESTION
DES DÉCHETS
NUCLÉAIRES