

Gichi-Inenjigaade  
weweni ji-  
bimiwijigaadegin  
Kaanada iwe gaa-  
aakwendaagwak  
Ishkwaakizigan

Zaagibagaa-giizis 2015

**nwmo**

NUCLEAR WASTE  
MANAGEMENT  
ORGANIZATION

SOCIÉTÉ DE GESTION  
DES DÉCHETS  
NUCLÉAIRES

# Gichi-Inenjigaade weweni ji- bimiwijigaadegin Kaanada iwe gaa- aakwendaagwak Ishkwaakizigan

## Gaa-ozhibii'igaadegin omaa

1	Nitam	4
2	Ji-wiidanokiimidiying Ji-izhiseg Ji-onizhishing Bimiwijigaadegin Gaa-aakwendaagwak Ishkwaakizigan.	5
3	Aaniin wiin Waa-doodang Kaanada-ogimaa?	6
4	Niigaan Ji-naanaagadawenjigaadeg Aaniin Ge-izhi-bimiwijigaadeg iwe	8
5	Wegonen iwe Gaa-aakwendaagwak Ishkwaakizigan?	10
6	Aaniin Noongom Ezhi-Ganawenjigaadeg?	12
7	Wegonen Wenizhishing Ji-izhi-mino- aabajichigaadegin Ini Ge-izhi-bimiwijigaadegin	14
8	Ji-Maanzhisesinog Gii-bimiwijigaadegin ini.	19
9	Bimiwijigewin Inaakonigewin gaye Ge-banaabanjigaadegiban	21
10	Ge-inwaadeg iwe NWMO Gaa-izhinikaadeg gaye Gaa-izhi-bagosnimindwaa ji-izhichigemagak	24
11	Ezhiseg Agaamakiing wiin	27
12	Gaa-ondinigaadeg Gaa-dazhindeg	30



# gichi-apiitendaagwad

## **MAAWACH GICHI-INENJIGAADE WEWENI JI-BIMIWIJIGAADEGIN INI GAA-AAKWENDAAGWAKIN ISHKWAAKIZIGAN.**

Gichi-inenjigaade iwe Kaanada akiing gaa-andawendang ji-izhichiged ji-ningwa'igaadeg iwe gaa-aakwendaagwak Ishkwaakizigan. Ji-onwaajigaadegiban aaniindi ge-izhi-ningwa'igaadeg booshke ajina eta iwe gaa-aakwendaagwak Ishkwaakizigan aazha zhaagooch igo ji-gashkichigaadeg ji-izhiwijigaadeg imaa.

## **ZOONGI-INAAGONIGEWIN DA-BIMINIZHA'IGAADE GAYE NAAGAJICHIGEWIN MEGWAA BIMIWIJIGAADEG IWE ISHKWAAKIZIGAN.**

Da-ayaamagan zoongi-inaakonigewin jibwaa-bimiwijigaadeg iwe gaa-aakwendaagwak ishkwakizigan. Kaanada Gaa-naagajichigaadeg lwe Gaa-aakwendaagwak Ishkwaakizigan Izhichigewin (CNSC) gaye Bimiwijigewin Kaanada wiinawaa inaakonigewag aaniin ge-izhichigeng bimijigaadeg iwe gaa-aakwendaagwak Ishkwaakizigan gaa-gii-aabadak. Bezhig izhichigewin miinawaa IAEA izhinikaade Miziwe Akiing Gaa-Dazhiikigaadeg lwe Gaa-aakwendaagwak Ishkwaakizigan Izhichigewin izhinikaade, amii dash gaye iwe ge-biminizha'igaadeg gaa-ikidowaad ji-doodamong weweni ji-bimiwijigaadeg iwe ishkwakizigan. Gakina gaa-daswewanagakin inaakonigewinan ji-biminizha'igaadegin ji-izhiseg weweni ji-bimiwijigaadeg, gaye weweni da-waawaabanjigaade. lwe NWMO gaa-izhinikaadeg Izhichigewin Gaa-Naagajichigaadeg iwe Gaa-aakwendaagwak Ishkwakizigan Gaa-Webinigaadeg Dash da-waabanda'iwewag ji-gashkitoowaad weweni ji-bimiwidoowaad iwe gaa-aakwendaagwak ishkwakizigan gaa-webinigaadeg dash.

## **GAA-WII-IZHI-BIMIWIJIGAADEG IWE GAA-AAKWENDAAGWAK ISHKWAAKIZIGAN DA-GANAWAABANJIGAADE AANIIN MAAWACH GE-MINOSEG GEGOON JI-MAANZHISESINOG JI-MAANZHIDOODAWINZIDWAA AWIYAG GAA-DAAWAAD IMAA.**

E-onendamowaad aaniindi waa-izhi-ningwa'amowaad iwe gaa-webinigaadeg gaa-aakwendaagwak Ishkwakizigan, igiwe NWMO gaa-izhinikaazowaad o-da-wiindaanaawaa wegonen ge-onizhishing giishpin izhi-bimiwidoowaad iwe ishkwakizigan giishpin bebakaan. Da-gagweijimaawag dash igiwe gakina ge-zaamishkaagowaad iwe giishpin besho imaa gaa-izhi-dazhiikewaad gemaa gaa-dananokiowaad, aaniin wiinawaa enendamowaad.

## **GINWESH AAZHA OWE DINOOKAAN BIMIDE BIMIWIJIGAADE GAAWIIN DASH GEGOON IZHI-MAANZHISESINOON MASHI.**

Aazja ginwesh o'owe dinookaan gaa-aakwendaagwak ishkwakizigan bimiwijigaade, gaawiin dash gegoon e-izhi-maanzhisesinog. Awashime 50 naanimidana-daso-biboon awashime 20,000 dasing bimiwijigaade o'owe, e-aabadak miikana, ishkode-odaabaanakana, gaye jiimaan. Omaa Kaanada akiing aazha niibiwa ngojigo maagizhaa niswaa dasing obimiwidoonaawaa owe apii 1960 gii-izhiseg, gegoo e-izhi-maanzhisesinog. Miziwe akiing gaye omaa Kaanada akiing, gaawiin awiya onji-bichishinzi, gaye ji-onji-maanishkaagod, gaye ji-onji-nibod, gaye aki ji-onji-maanzhisesinog gaa-inendaagwak iwe gaa-aakwendaagwak ishkwakizigan, aaniish maji-gegoon onji-waasikwanedog imaa gaawiin dash naagwazinoon.

# 1 Nitam

Owe mazina'igan waabanda'iwemagan aaniin ezhi-bimiwijigaadeg iwe dinookaan bimide, gaa-onwaadang Kaanada ogimaawiw in ji-dazhiikang iwe gaa-webinigaadeg gaa-aakwendaagwak ishkwaakizigan, gaa-gii-onji-ozhichigaadeg waasiganing.

Iwe NWMO izhichigewin 2002 gii-izhiseg, o-gii-ozhitoonaawaa igiwe Kaanada ogimaawiw in gaa-ozhitoowaad iwe gaa-aakwendaagwak waasigan, e-gii-biminizha'amowaad iwe inaakonigewin NFWA Aaniin GE-Doojigaadeg Iwe Gaa-aakwendaagwak Waasigani-bimide Gaa-gii-aabadak. Amii enwaadeg iwe inaakonigewin ji-wiidanokiimindwaa Kaanada gaa-ayaawaad awiyag, gaye ji-izhi-biminizha'amowaad iwe inaakonigewin ji-dazhiikamowaad ginwesh iwe gaa-gii-aabadak gaa-aakwendaagwak ishkwaakizigan, ji-onji-maanzhisesigwaa igiwe besho imaa gaa-daawaad gaa-anokiwaad, gaye ji-maanzhidoojigaadesinog aki gaye nibi, gaye dash ji-onji-zhooniyaakemagak.

Iwe NFWA ji-anokiimagak andawenjigaazowag igiwe gaa-ozhitoowaad iwe gaa-aakwendaagwak waasigani-bimide ji-asaawaad zhooniyaan ge-aabadizid ji-ningwa'igaadeg iwe gaa-aakwendaagwak ishkwaakizigan gaa-webinigaadeg, ji biminizha'igaadeg inaakonigewin gaye gaa-ikidowaad Ontario

Waasigan Izhichigewin (Ontario Power Generation), Waasigan Quebec (Hydro Quebec), Waasigan New Brunswick (New Brunswick Powe Corporation) gaye dash Kaanada Gaa-aakwendaagwak Waasigan (Atomic Energy of Canada Limited AECL) amii dash gii-maajii-asaawaad endaso-biboon ini zhooniyaan. Amii awe zhooniya ge-aabadizid ji-bimiwijigaadeg iwe gaa-wii-izhichiged Kaanada, iwe bimiwijigaadeg iwe bimide.

Kaanada aazha ganawenda'iwewag ini gaa-aakwendaagwak ishkwaakizigan ajina goda omaa Ontario akiikaaning, Quebec akiikaaning, gaye New Brunswick akiikaaning AECL e-ayaad ini. Gaye dash imaa AECL gaa-izhi-naanaandogikenjigewaad Ontario gaye Manitoba.

Owe dash NWMO izhi-bagosenimaa ji-izhichiged ji-onwaadang gaye ji-ozhitood aaniin ge-izhi-weweni-bimiwijigaadeg iwe gaa-aakwendaagwak ishkwaakizigan imaa ji-onji-maajiiwijigaadeg noongom gaa-dazhi-ganawenjigaadeg, wedi dash bakaan ji-izhiwijigaadeg gaa-izhi-asiniikaag ji-izhi-ningwa'igaadeg.

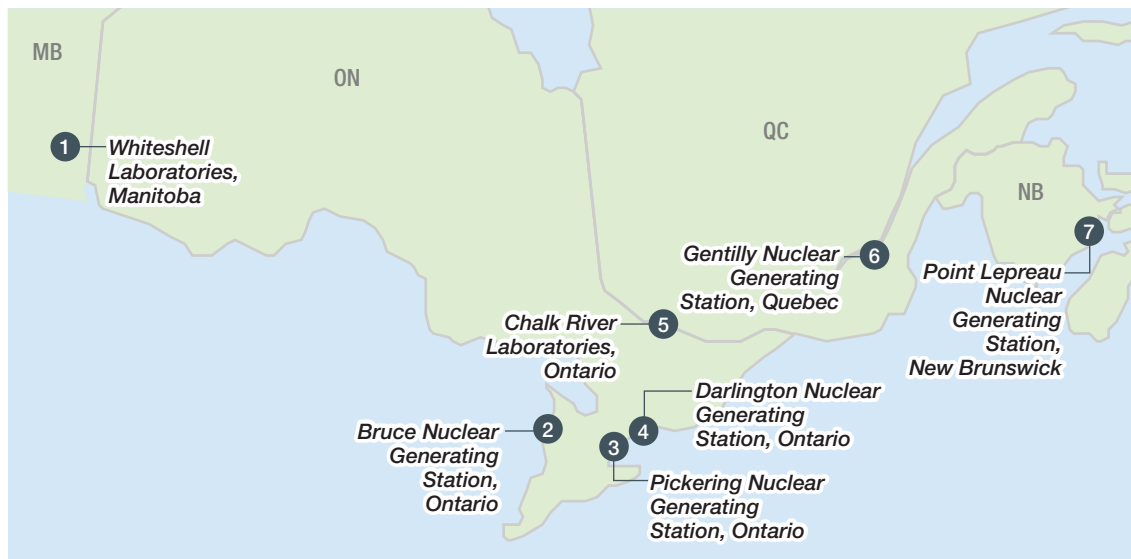

Kaanada nishwaachinoon gaa-dazhiikigaadeg gaa-aakwendaagwak ishkwaakizigan

## 2 Ji-wiidanokiimidiying Ji-izhiseg Ji-onizhishing Bimiwijigaadegin Gaa-aakwendaagwak Ishkwaakizigan

Gakina gi-bagosendaagozimin omaa Kaanada gaa-ayaaying ji-wiijitwaaying ji-ganawenjigaadeg iwe gaa-aakwendaagwak ishkwaakizigan. Amii e-gagwe-izhichiged Kaanada gaa-anokaadamowaad owe ji-izhiwijigaadeg owe gaa-aakwendaagwak ishkwaakizigan ningoji ji-dazhi-ningwa'igaadeg ge-ateg gabeya'ii. Giishpin dash bimiwijigaadeg iwe ishkwaakizigan, da-izhichigewag weweni ji-izhiseg, ji-nishiwanaajichigemagazinog giishpin bangising gemaa baashkisesg gaa-izhi-biindeg, ji-onji-maanishkaagosigwaa bemaadiziwaad gaye aki. Iwe dash izhichigewin NWMO gaa-izhinikaadeg, ogikendaanaawaa aaniin ge-ayizhiwaad iwe ji-doodamowaad, gaye o-da-gagwejimaawaa' awiya gaa-daawaad ngoji aaniin wiinawaa ezhi-nisidotamowaad gaye ji-ikidowaad enendamowaad, gaye wii-gagwedwewaad gegoon. Gi-gagwejimigoom ji-dagwiiyeg.

Gaawiin mashi gii-gagiiginigaadesinon aaniindi ge-izhi-ningwa'igaadeg iwe gaa-gii-ishkwa-aabadak gaa-aakwendaagwak waasigani-bimide, baanimaa ngojigo niishtana gemaa nisimidana daso-biboon izhiseg iwe da-onwaade. Noongom dash ni-wii-maajii-gagwedwemin aaniin enendamowaad awiyag. Owe ni-wii-izhichigemin:

- » Ji-wiindamaagooyeg aaniin ezhi-bimiwijigaadeg iwe dinookaan gaa-aakwendaagwak ishkwaakizigan omaa Kaanada akiing;
- » Ji-nakwetamaang gaa-izhi-gagwejimigooyaang gaa-wii-izhi-bimiwidood gaa-aakwendaagwak ishkwaakizigan; gaye dash
- » Ji-dagwii'igooyeg owe dazhinjigaadeg.

Biiizhaakeg maawaji'iweyaang gichi-waakaa'iganing jiigiya'iing gaa-dazhikeyeg maagizhaa gaye ando-waabam igi NWMO gaaa-anokiiwaad imaa NWMO ozhibii'igewigamigong gaa-ayaayeg, gemaa maamaagonen manaandaawaabikonk NWMO gaa-izhi-ozhibii'igaadeg gegoon, ji-wiindamaageyeg gegiinawaa enendameg.



# 3 Aaniin wiin Waa-doodang Kaanada ogimaa?

Amii wiin waa-izhichiged Kaanada aki gaa-anokaadamowaad owe ji-ningwa'igaadeg iwe gaa-aakwendaagwak ishkwakizigan - Naanekaw Ji-Naagajichigaadeg Izhichigewin odizhinikaadaanaawaa(APM). 2002 gii-izhiseg biinish 2005, o-gii-gaganooanaawaa Kaanada akiing gaa-ayaanid awiya', amii dash iwe ezhi-gikenjigaadeg maawach ge-minosegiban ji-izhichigeng. Gichi-ogimaawiwinn dash o-gii-odaapinaanaawaa iwe APM ji-izhichigewaad omaa Kaanada akiing Ode'iminigiizis 2007 gii-izhiseg.

Iwe dash izhichigewin NWMO andawendamooq maawach weweni ji-bimiwijigaadeg iwe gaa-aakwendaagwak ishkwakizigan. Da-andwenjigaadeg gaawiin ji-zaamishkaagosigwaa bemaadiziwaad gaye aki nepij igo. Amii noongom e-gagwe-mikamowaad aaniindi ge-gii-izhi-nepiji-ningwa'igaadeg iwe ishkwakizigan, gaa-izhi-asiniikaag.

Ozhichigaadeg owe, amii gaye imaa ge-izhi-danakamigak ji-dazhi-anokaadeg iwe miziwekamig ji-onjiwaad gewiinawaa iwe gaa-dazhiikamowaad bakaan agaamakiing.

Amii dash NWMO onandawenimaawaa' ge-ikidonid bizaanigo imaa jiiigiya'iing gaa-danakiwaad ji-bagidinamowaad owe gaa-aakwendaagwak ishkwakizigan ji-ningwa'igaadenig. Aazha NWMO o-gii-maajii-nanaandone'aanaawaa iwe May 2010 gii-izhiseg, ji-gagwe-mikamowaad aaniindi ge-izhi-ningwa'igaadeg iwe ishkwakizigan. Ginwesh da-izhise ji-babaa-wiindamaageyaang dazhiikewining gaye ji-odaapinamaang awiyag ekidowaad enendamowaad, gaye ji-gagwejichigaadeg iwe aki ge-danakamigikiban jibwaa-onwaajigaadeg aaniindi iwe ge-izhiseg.

Owe dash izhichigeng, niibiwa zhooniyaa da-aabadizi ji-ozhichigaadeg iwe ge-izhi-ningwa'igaadeg iwe ishkwakizigan, da-onji-

zhooniyakewag dash imaa gaa-ayaawaad besho, gaye iwe akiikaan ge-danakamigak. Gaa-izhi-asiniikaag eta owe da-izhi-minose, gaawiin wiin gaa-izhi-azhashkiwang eta aki. Da-inakamigan giishpin eta inendamowaad igi besho imaa gaa-dazhiikewaad, gaye Anishinaabeg, gaye Wiisaakodewiniwag gaye oodenaawan gaa-ayaamagakin imaa besho ji-dagwiwaad iwe izhisenig.

Iwe NWMO gaa-izhinikaadeg amii ezhi-andawendamowaad ji-biminizha'amowaad gakina inakonigewinan gemaa ji-baazhiji-biminizha'amowaad ji-izhiseg weweni, ji-maanzhisesigwaa bemaadiziwaad gaye aki.

Ayaamagan inakonigewin ge-biminizha'igaadeg weweni ji-bimiwijigaade ishkwakizigan. Imaa noongom ajina gaa-izhi-ganawenjigaadeg iwe gaa-aakwendaagwak ishkwakizigan ji-onjiwijigaadeg, niizhwaachinoon aaniish inin noongom gaa-izhi-ganawenjigaadeg, da-andooshkigaade mazina'igan ge-aabadak ji-bimiwijigaadeg iwe ishkwakizigan, CNSC dash da-gagwejimaawag iwe mazina'igan gaye ji-anokiinaaniwang imaa ge-danakamigak. Giiyaabi awiya wii-gikendang owe APM gaye iwe izhichigewin, omaa izhi-maamaagonigen: [www.nwmo.ca](http://www.nwmo.ca).

# Aaniin Ezhinaagwak Iwe Dinookaan Gaa-Izhi-Ningwaa'igaadeg Ishkwaakizigan

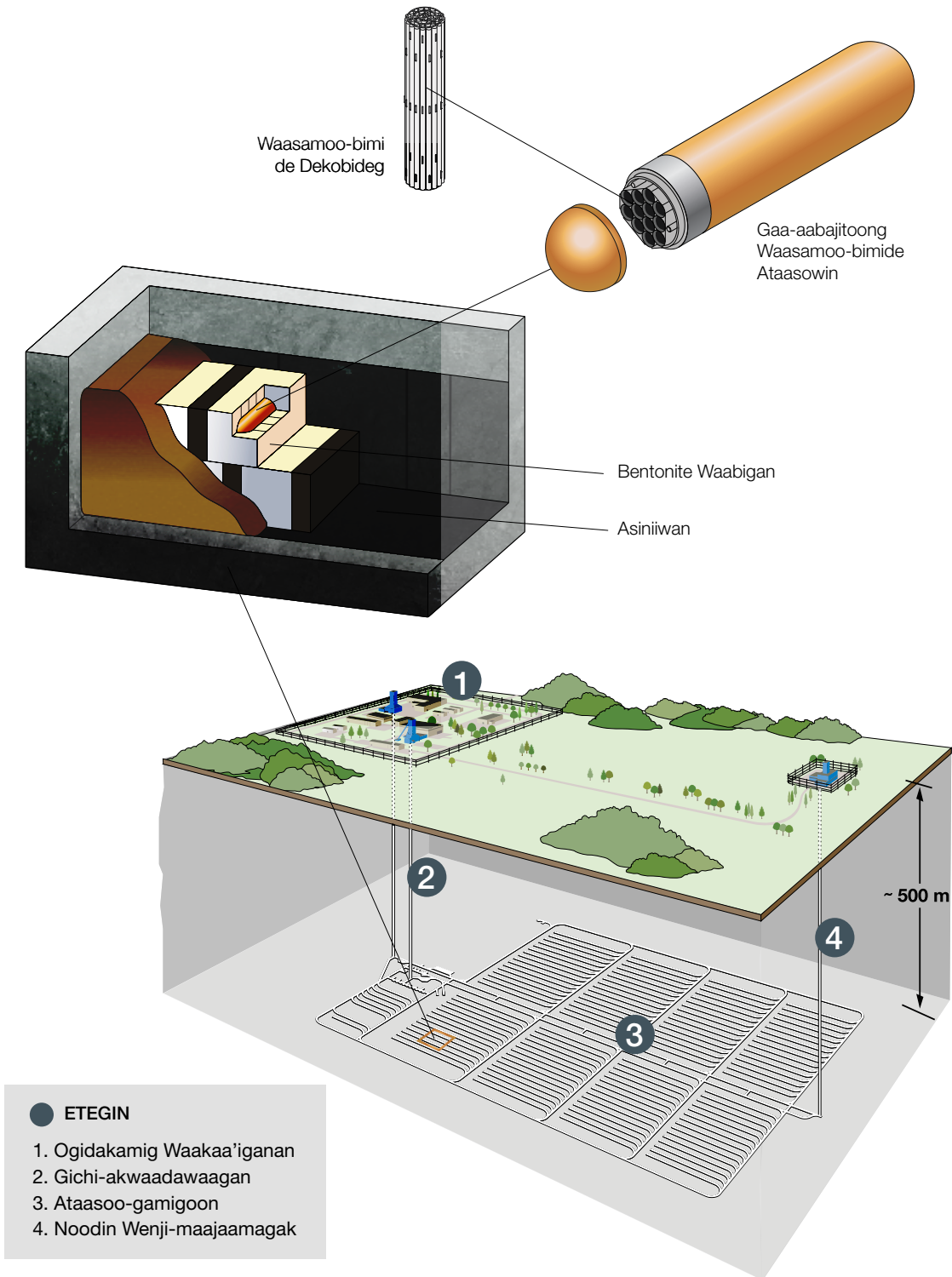

# 4 Niigaan Ji-naanaagada-wenjigaadeg Aaniin Ge-izhi-bimiwijigaadeg iwe

Iwe NWMO gaa-izhinkaadeg nitam o-da-waabanda'aawaa' ini gaa-inaakonigewaad gaye igi awiyag gaa-izhidaawaad imaa besho aaniin epiichi-naniizaanendaagwazinog owe gii-bimiwijigaadeg gaa-aakwendaagwak ishkwaakizigan.

Jibwaa-gagiiginigaadeg aaniindi ge-izhi-ningwa'igaadegiban iwe ishkwaakizigan, binamaa daa-onwaaajigaade aaniindi ge-bimi-izhaamagakiban iwe gaa-bimiwijigaadeg iwe gaa-aakwendaagwak ishkwaakizigan ji-onjimagak noongom gaa-dazhiganawenjigaadeg, ji-izhaamagak dash ge-izhi-nepiji-ningwa'igaadeg.

Giishpin ini izhichiganan gaa-dazhi-ozhichigaadeg iwe gaa-aakwendaagwak waasigan ginwesh aabajichigaadegin, gaye ngoding wawezhichigaadegin zoongichigaadegin, owe minigok gaa-aakwendaagwak ishkwaakizigan da-ayaamagan 4.6 aaniin baakach daswaak, amanch goda minik ge-aabadanogwen ani-akiwang. Amii Kaanada aki gaa-gii-izhi-onendang aanin ge-izhi-naagajitood iwe dinookaan gaa-aakwendaagwak ishkwaakizigan. Gaawin bakaan akiing daabishkoo zhaawanong da-bi-ningwa'igaadesinooon omaa gidakiiminaaning ge-dibendang APM.

Aazha NWMO o-ii-ozhitoonaawaa aaniin ge-izhichigeng ji-onwaaadeg aaniin ge-izhi-mikigaadeg owe ge-izhi-ningwa'igaadeg bimide. Nitam o-da-naanaagadawaabandaanaawaa giishpin ji-onizhishing ji-bimiwijigaadeg imaa akiing, aaniindi ge-bimi-izhaang gaye aaniindi

ge-izhi-bakebizonaaniwang. Aazha NWMO gii-maajitaawag gaye aaninda dazhiikewinan e-ikidowaad e-wii-gikendamowaad giyaabi. Nitam da-aabajichigaadeg gikendaasowin ji-gikenjigaadeg giishpin eyaamaganogwenan miikanawan gemaa ishkode-odaabaanakanawan maagizhaa gaye ji-oshki-ozhichigaadegibaniin miikawan ge-aabadakin. Giyaabi da-naanaagadawaabanjigaade aaniin mayaa ge-gii-izhichigenaaniwangiban, aaniindi gaye aaniin mayaa.

Awashime 50 naanimidana daso-biboon aazha bimiwijigaade iwe gaa-gii-ishkwaa-aabadak gaa-aakwendaagwak waasigani-bimide miziwe akiing, owe minik e-bimiwijigaadeg 20,000 minik daswaa, miikanawan gaye ishkode-odaabaanakanawan gaye jiimaan an e-aabadakin. NWMO dash andawendamoo miikanawan gaye ishkode-odaabaanakanawan ji-aabaadakin. Amii aazha iwe ezhi-nisidawinaagwak maawach ji-minosegiban ji-izhichigeng.

Gagwe-mikamowaad aaniindi ge-izhi-ningwa'igaadeg iwe bimide, o-da-ganawaabandaanaawaan aaniindi ge-izhi-bimi-izhaamagak iwe ishkwaakizigan. Da-ganoonaawag gaye besho imaa gaa-izhidaawaad ji-gikenjigaadeg enendamowaad.

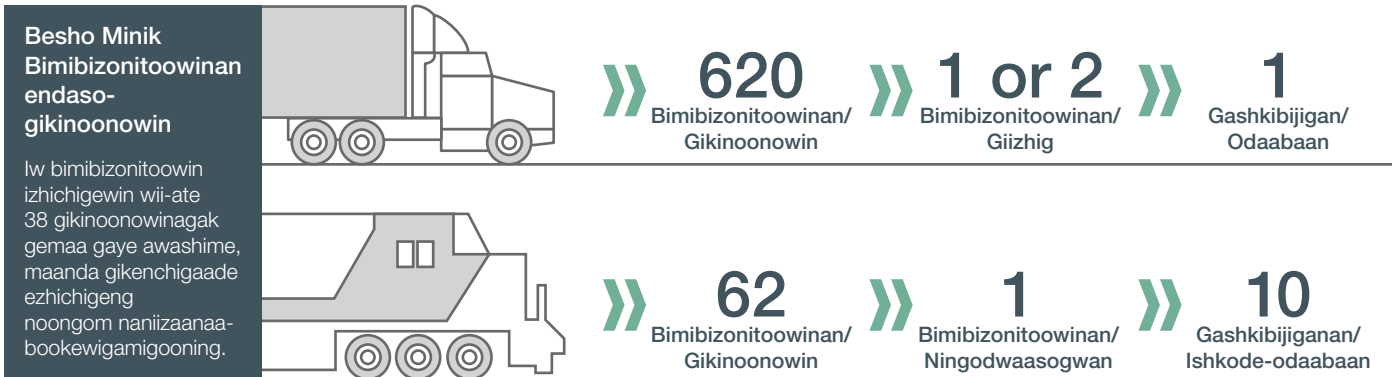

Apii maajichigaadeg ningwa'igaadeg iwe ishkwaakizigan waasa niigaan ani-akiwang, iwe gaa-aakwendaagwak ishkwaakizigan da-izhiwijigaade imaa gaa-wii-izhi-ningwa'igaadeg ji-de-ningwa'igaadeg apii dagoshinoomagak imaa, gaawin wiin ji-michi-ayate imaa dagoshinoomagak. Bebakaan daa-ayaamaganooon ge-izhi-bimiwijigaadeg gaawin wiin eta bezhigwayak. Wegonen igo ge-minoseg maawach.



Apii dash gaa-onwaajigaadeg aaniindi ge-izhi-ningwa'igaadeg bimide, NWMO da-waabanda'iwe aaniin ge-izhi-bimiwijigaadeg iwe ishkaakizigan, ji-biminizha'igaadegin gakina inaakonigewinan. NWMO maawach ge-minoseg da-gagwe-izhichigewag weweni ji-bimi-ayaamagak gaye ji-epemiwaad giishpin gegoon izhiseg iwe gaa-bimiwijigaadeg, daabishkoo giishpin opimeseg, ziiigseg. Ji-naadamawindwaa bemaadiziwaad gaye aki izhi-andawenjigaade. Owe da-gagwe-izhichigewag:



**Mashkawisin,**  
gaa-gagwejitoo  
g miinawaa  
gaa-gikenjigaad  
eg  
bimibizonitoong  
gashkibijigan



**Booch**  
gaa-nanaa'itoong  
ji-gichi-bimibizonit  
oong miinawaa  
ishkode-odaabaan-  
ing ji-dazhi-  
ayaangwaa  
mizing miinawaa  
akawaabanchigeng



**Bimibizonito**  
owin  
Akawaabanc  
hige  
win  
Inaakonigew  
in  
atemagad



**Wewiib**  
Naadamaagewin  
Inaakonigewin  
atemagad



**Booch**  
gaa-nanaa'itoong  
ji-aaming  
bimibizonitoowini  
-mazina'igaans



**Memeshkwad**  
agindaasong  
miinawaa  
asigigindaasong  
ji-onji-inaakonige  
ng

Gaa-onizhishing bimijigewin, gaa-zoongak, gaye gaa-gii-gagwejichigaadeg aazha. Da-zoongiziwag odaabaanag ge-aabadiziwaad. Gaye da-ayaamagan ge-izhichigeng giishpin gegoon izhi-maanzhiseg megwaa bimi-ayaamagak iwe bimide. Aaniin ge-ayizhiinaaniwang da-ate imaa. O-da-debinaanaawaa mazina'igan ji-bagidinindwaa igi ge-bimijigewaad ji-inanokiwaad iwe. Naanigoding da-naanaagadawaabamaawag igi ji-gikenjigaadeg debwe gwayak e-izhichigewaad.

Kaanaka ogimaawiwini o-da-biminizha'aan iwe CNSC gaye Kaanada Bimijigewin gaa-andooshkamowaad NWMO ji-waabanda'iwed e-wii-biminizha'ang gakina inaakonigewinan jibwaa-miigiwed CNSC iwe mazina'iganens ji-bagidinigaadeg ji-bimiwidamowaad iwe ishkaakizigan ji-awiningwa'igaadeg (waabandan Inaakonigewin 9. Bimijigewin Inaakonigewin gaye Ganawaabanjigewin). Gaye dash gaawin wiin eta iwe ji-biminizha'igaadeg inaakonigewin gaa-wiindeg omaa, NWMO gaye da-waabanda'iwe wag aaniin waa-izhichigewaad giishpin gegoon izhiseg, aaniin ge-izhi-gikino'amawaawaad odanokiimaaganiwaa' gaye aaniin ge-izhi-ashowizimid.

NWMO onisidawinaan niibiwa gegoon ji-gagwe-izhichiged weweni ji-izhi-bimiwidood iwe:



**Weweni**  
ji-gii-gikino'ama  
windwaa  
ge-anokiwaad  
gaye ge-  
bimibizowaad ini  
odaabaanan.



**Weweni ji-bimizowaad**  
gaye ji-gikendamowaad  
aaniin ge-ayizhiwaad  
gichi-zoogipong gaye  
maanamok miikana  
gaye weweni  
ji-gibichiwaad gaye  
ji-gikino'amawindwaa  
aaniin e-ayizhiwaad  
waawaagamok.



**Ji-gikino'amawin**  
dwa aaniin  
ge-izhichigewaa  
d giishpin  
gegoon izhiseg,  
maanzhiseg  
gegoon.



**Ji-wiindamawaaw**  
aad awiya' apii  
maajii-naanaagad  
awenjigaadeg  
aaniin ge-  
izhichigenaan-  
iwang.



**Iwe APM**  
izhichigewin  
ji-waawaabanjiga  
adeg giishpin  
menosegwen  
gaye aaniin  
ge-izhi-minochiga  
adegiban aanjiike  
naagach.

# 5 Wegonen iwe Gaa-gii-aabajichi-gaadeg Gaa-aakwendaagwak Ishkwaakizigan?

Amii iwe gaa-gii-ishkwaa-aabadak gaa-aakwendaagwak ishkwaakizigan, apii gii-ozhichigaadeg waasigan, bichiboowaabo ishkose. Amii iwe gaa-izhinikaadamaang gaa-aakwendaagwak ishkwaakizigan omaa. Amii dash iwe waasigan aapiji ginwesh aakwendaagwan naniizaanendaagwan. Aaniish aapiji bichiboowaagamin. Giishpin mishwesing daa-onji-aakozi awiya. Giishpin besho imaa ayaad bemaadizid. Wiinge eta aayiji-ganawenjigaadeg gaawiin daa-gikendaagosinon iwe bichiboowaabo. Aanawi ningoding da-ani-aanisimiimagan aapiji ginwesh apii iwe. Amii ge-onji-andawenjigaadeg ji-nepiji-ningwa'igaadeg ozaam e-bichiboowang. Gaawiin wiin gaye debwe nibiwanzinon. Daabishkoo asiniing inendaagwan. Gaawiin gaye inendaagwazinon ji-biskaneg gaye ji-baashkideg.

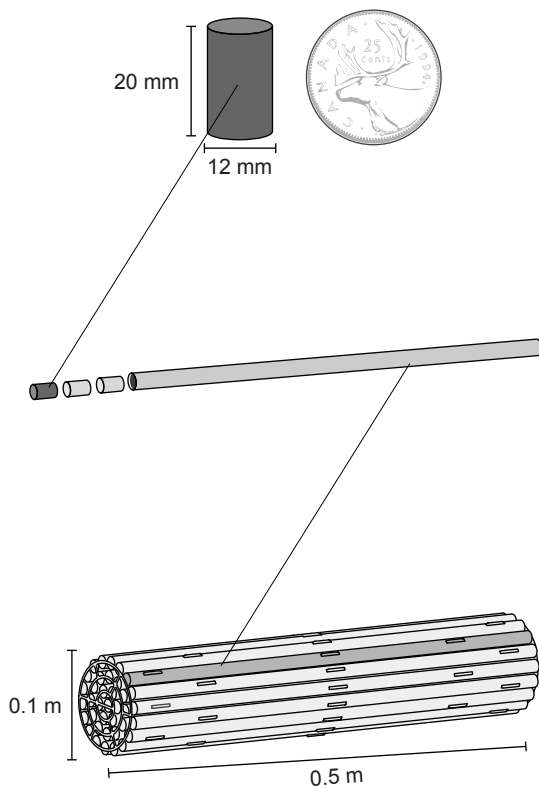

## Bichiboowi-bikwaakodominagoons

Ono gaa-agaasingin daabishkoo anwiinsan gaa-izhinaagokin uweniyam daayaaksaa'id onji-ozhichigaadewan, gichi-boodawaanaabikong dash gii-izhi-gizhizigaadewan biinish gii-mashkawaakodegin. Gaawiin nibiing daa-oke-ningaabaawesinonon, gaaawiin gaye gichi-gizhideg geoon daa-izhisesinonon.

## Bimidewi-ozhibii'iganaakoog

Ini dash bikwaakodominagoon ganawenjigaadewan biinjisinon ozhibii'iganaakong dash izhinikaadewan ini daabishkoo aaniish ozhibii'iganaakoog izhinawanoon. Amii dash ezhi-agozigaadegin ini ji-maamichaagin ini.

## Bimide-Maawadoopijigan

Endaso-maawadoopijigan onji-ozhichigaadewan ini ozhibii'iganaakoog gaa-ishkwaa-wiindegin omaa. Aapiji gaa-zoongak biiwaabik ziirkalooy izhinikaade iwe biiwaabik. Daabishkoo bezhig mishi inigokwaawan ini maawadoopijiganan, ngoji go dash niishtana-shi-niiwin daso-oshki-dibaabiishkoojigan apiitinigonon. Jibwaa-biina'igaadegin imaa gichi-biindaapika'iganing, gaawiin aapiji naniizaanendaagosinonon ini. Ningojigo 0.05 mSv/h apiitendaagwan. Apii gii-biindegin imaa gichi-biindaabika'iganing endaso maawadoopijigan ozhichigemagan waasigan ji-debisegiban 100 ningodwaak waakaa'iganan ji-aabajitoowaapan waasigan ango-aki.

Giishpin nawaj gegoo waa-nandagikendaman maanda izhichigewin, daga izhaan imaa Canadian Naniizaanaaboo Wawiingeziwin Enokijig waasamowin-asabiing gikendaasoomakakoong: [www.nuclearsafety.gc.ca/eng/resources/radiation/index.cfm](http://www.nuclearsafety.gc.ca/eng/resources/radiation/index.cfm). The Omaa mazina'iganing ji-gikendaming izhichigewinan izhitoong iw neniizaanak waasamowin.

## Naagajichigade iwe Gaa-naniizaanendaagwak Bizhishig Gii-dazhiikigaadeg iwe Aabajichigan.

Apii gii-odaapinigaadeg iwe ishkwaakizigan imaa gichi-biindaabika'iganing, aapiji naniizaanendaagwan. Aanawi ningoding gaawiin da-naniizaanendaagwasinon, giiyaabi aapiji ginwesh da-naniizaanendaagwan iwe. Gichi-inendaagwan weweni ji-naagajichigaadeg.

Nitam niibiwa maajaamagan iwe gaa-naniizaanendaagwak apii gii-onji-odaapinigaadeg imaa gichi-biindaabika'iganing. Ningojigo 99% angwiimagan 10 midasobiboon gii-izhiseg. Bangii dash eta gaawiin wiin ini niibiwa.

Kaanada odayaan inaakonigewin ge-naagaji'iwemagak owe dinookaan ishkwaakizigan. Bizhishig agwana'igaade iwe gaa-gii-aabadak ji-onji-naniizaanendaagwasinog iwe omaa.

Kaanada aazha ginwesh onji-dazhiikigaade owe. Gaa-danakamigak dakisijigaade iwe e-aagawising nibiing e-agewandeg, e-ganawenjigaadeg. Gaa-dazhi-ganawenjigaadeg noongom jibwaa-nepiji-maajijigaadeg, noongom gichi-waakaa'iganing izhi-ganawenjigeaade asiniikandaadewan ini waakaa'iganan. Iwe nibi gaye asiniikaan aagawishkaagemagan. Gii-maajiwijigaadeg biinde imaa gaa-izhi-zoongichigaadeg ji-bimi-ayaamagak. Baanimaa anaamaabik izhi-ningwa'igaadeg.

Amii ezhi-gagwe-izhichigeyaang jii'ing gaa-ayaawaad awiyag ji-zaamishkaagosigwaa waasa ji-bimi-ayaamagakin ini, apii bimiwijigaadegin ningoji.

# 6 Aaniin Noongom Ezhi-Ganawenjigaadeg?

Iwe gaa-aakwendaagwak ishkwakizigan izhi-ganawenjigaadeg enikibiig nibiing gemaa ezhi-bengwakin gaa-danakamigak.

Apii iwe gaa-gii-ishkwaa-aabadak gaa-aakwendaagwak ishkwakizigan gii-onji-odaapinigaadeg gichi-biindaapika'iganing webinigan inenjigaade. Aapiji naniizaanendaagwan. Weweni dash doojigaade. Nitam nibiing izhi-achigaade ji-onji-dakaabaaweg. Ningoji niizhwaaso-biboon gemaa midaaso-biboon da-agwande imaa. Maagizhaa gaye gaa-izhi-bengwak da-izhi-ganawenjigaade akawe. endaso-danakamigak CNSC ayaamagank endazhi-ganawenjigaadegin ini weweni

naagadawaabanjigaadewan gegoon ji-izhiseg bemaadziig gemaa aki, gaye ji-biminizha'amowaad gakina inaakonigewinan omaa akiing gaye agaamakiing.

Noongom omaa Kaanada akiing, ngojigo 2.5 niibiwa daswaak ini maawadoopijiganan ganawenjigaadewan nibiikaang gemaa gaa-izhi-bengwak gaa-asiniikandaadeg izhi-makakokaanan gemaa waawiyeyiyyaawan ini waakaa'iganikaanan.

Gaa-aakwendaagwak ishkwakizigan agwande imaa nibiing. Dakaabaawewan ini maawadoopijiganan gaye gaawin gikendaagosinon iwe gaa-bichiboo-shkaagemagak.



Ontario Waasigan  
Jenereshin gaa-bengwak  
waakaa'iganikaan  
odizhi-  
ganawendaanaawaan  
maawadoopijiganan.



Point Lepreau  
gaa-bengwakin gaa-izhi-  
ganawenjigaadeg iwe.



Gentilly - 2 gaa-bengwak  
gaa-izhi-  
ganawenjigaadegin.



# 7 Wegonen Wenizhishing Ji-izhi-mino-aabajichigaadegin Ini Ge-izhi-bimiwijigaadegin

Ji-minoseg bimiwijigaadeg iwe ishkwakizigan nindizhitoomin owe bimiwijigewi-izhichigewin. Apii gii-maajitooyang nin-gii-ganawaabandaamin iwe. Gaa-aakwendaagwak ishkwakizigan ji-bimiwijigaadeg gegoon ji-maanzhisesinog nidizhi-ganawaabandaamin. Iwe izhichigewin CBSC gaa-izhinikaadeg izhibagosenjigaade weweni ji-ganawaabandamowaad owe dinookaan bimiwijigewin, gegoon ji-izhi-maanzhisesinog gaye ji-ozhichigaadegin e-aabajichigaadegin izhinizha'iganan gaye ji-naagajichigaadeg gii-maajinizha'igaadegin gegoonan.

Aanind iniw gaa-aabajitoong naniizaanaaboo bimibizonitoong gashkibijiganan gaa-gikenchigaadegin ji-aabajichigaadegin Canada, gaye Gaa-aabajitoong Naniizaanaaboo Bimibizonitoong Gashkibijigan (UFTP) miinawaa iw Bayaateg Ataasowin Bimibizonitoong Gashkibijigan (DSC-TP), wayaabanda'aming imaa mazina'iganing 15. Jibwaa-aabajitoong iw bimibizonitoong gashkibijigan Canada, gaa-izhi-ozhichigaadeg daa-gikenjigaade imaa CNSC ji-onizhishing ganawaabanchigaadeg, gaye atewan miziwekamig ayaangwaamiziwin gikinoowaabanjiganan. Waa-ayaaming goji-gikendamowinan ji-waabanjigaadeg izhi-ayaag iw gashkibijigan giishpin wii-biigosing, wii-jaagideg miinawaa wii-agwandeg.

Apii gaa-gikenjigaadeg ji-zhiibang iwe, CNSC da-miigiwe mazina'igan ezhibii'igaadeg bizaanigo ji-aabadak iwe. Da-izhisin gaye aaniin ge-ayizhiing ji-ozhichigaadegin ini ge-izhi-bimiwijigaadeg iwe, gaye ji-izhi-bimibizong, gaye ji-naagajichigaadeg iwe bimi-ayaawin. Gaye da-ozhibii'igaad wegonen ge-bimiwijigaadeg imaa. Naano-biboon da-ako-onizhishin iwe mazina'igan. Ishkwaaseg iwe naano-biboon, NWMO miinawaa o-da-andooshkaan oshki-mazina'igan ji-debinang miinawaa iwe bimiwijigewin.

NWMO onaanaagadawaaband-aanaawaa gii-bimiwijigaadeg iwe gaa-gii-ishkwaa-aabadak gaa-aakwendaagwak waasiganaabo e-aabadak iwe UFTP gaye DSC-TP ozhichiganan.

## Gaa-aakwendaagwak Ishkwaakizigan Bimiwijigewin

Iwe UFTP bimiwijigewin nisinoon gegoonan imaa: iwe gaa-izhi-biindeg, giba'igan, iwe dash ge-onji-zoongak. Iwe gaa-izhi-biindeg gaye giba'igan biiwaabikong onji-ozhichigaade ngojigo dash ango-mizid apiitaabikan, epiichi-zoongak. Iwe dash giba'igan 32 nisimidana zaga'iganan aabadanoon ji-aayiji-gashkaabika'igaadeg. Iwe dash ge-onji-zoongak miskwaatig gaa-izhinikaazod mitig aabadan jibiindeg iwe, biiwaabik dash miinawaa e-aabadak imaa. Ji-gichi-izhishinzinog giishpin bitaakoshing awe odaabaan gaa-bimibizod iwe inwaade. Gaawiin eta aabiding daa-aabadazinooon iwe gaa-bimiwijigemagak, 192 dash daswaatik daa-bimiwijigaadewan ini maawadoopijiganan gegaa 35 daso-gichi-dibaabiishkoojigan daa-apiitinigwanooon.

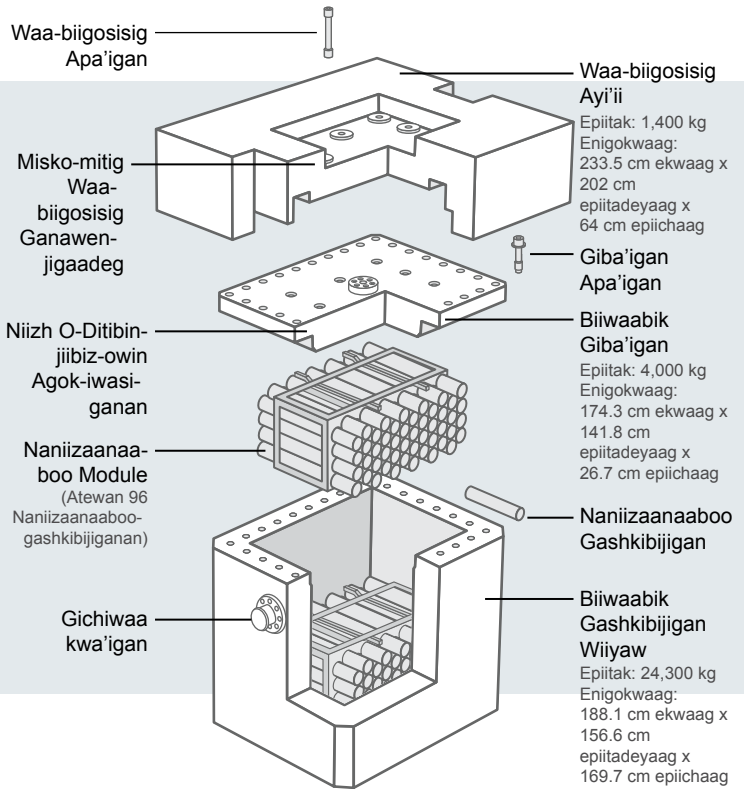

## Wenji-baateg Ataasowin Bimibizonitoong Gashkibijigan

Epiitak: 100,300 kg  
Enigokwaag: 367 cm ekwaag x 337 cm epiitadeyaag x 595 cm epiichaag

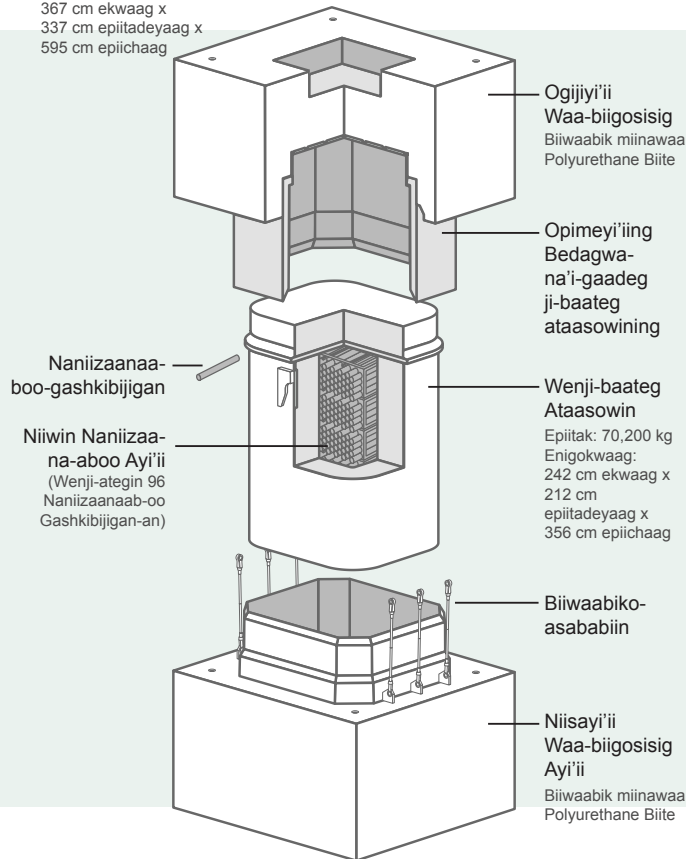

## Gaa-bengwak gaa-izhi-bimiwijigaadeg iwe

Iwe gaa-aakwendaagwak ishkwaakizigan noongom ganawenjigaade ajina gaa-izhi-bengwakin makakoon DSC imaa Ontario Waasigan Jenereshin Gaa-izhi-ganawenjigaadeg webinigan. Iwe dash DSC-TP ayaamagan DSC gaa-ategin gaa-zoongichigemagakin e'iidaw.

Iwe DSC ayaamagan iwe gaa-izhi-biindeg gaye giba'igan asiniikaan onji-ozhichigaade gaye dash biiwabik ogijiya'iiing. Iwe DSC gaa-izhi-biindeg gaye iwe giba'igan agozigaadewan gaa-ishkwaabiina'igaadeg iwe ishkwaakizigan. Miinawaa dash ini ge-onji-zoongichigaadeg giishpin bitaakoshaagemak iwe. Biiwaabiko-zhinoodaaganan aabadanoon ji-aayiidapidegin. Iwe DSC onji-zoongan iwe, ini dsh gaa-zoongichigemagakin da-wiiji'iwemagan giishpin bitaakosing iwe gaa-bimiwijigaadeg. Iwe gaye DSC bizaanigo 384 minigok maawadoopijiganan daa-bimiwijigaadewan gaye 100 gichi-dibaabiishkoojigan apiitinigwan gii-mooshkinachigaadeg.

Iwe UFTP gaye DSC-TP izhichigaadewan gaye gii-gagwejjichigaadewan gaye gii-ozhibii'igaadewan geget e-ziiigisesinog gaa-bimiwijigaadegin biinjya'ii giishpin bitaakoshkaaged awe odaabaan.

CNSC odaabajitoonaawaa niswayag izhichigewin ji-minoseg gii-bimiwijigaadeg iwe gaa-gii-ishkwaa-aabadak gaa-aakwendaagwak waasiganaabo.

1. CNSC miigiwe mazina'iganens ezhichigaadeg iwe.
2. CNSC omiinaa' gaa-bimiwidoonid iwe gegoon.
3. CNSC miigiwe mazina'iganens ji-bimiwijigeng.

Iwe dash mazina'iganens gaa-aabadak izhibii'igaade e-biminizha'igaadegin ge-minoseg daabishkoo ji-ziiibisesinogin gaa-bimiwijigaadegin giishpin bitaakoshkaaged odaabaan. Inaakonigewinan (Gii-gashkaabika'igaadegin gaa-bimiwijigaadegin gaye Gii-bimiwijigaadeg Gaa-aakwendaagwakin Gegoonan Inaakonigewinan gaye IAEA Inaakonigewinan ji-Weweni-bimiwijigaadeg Gaa-aako-bichiboowang Gegoon) bizaanigo ji-gagwejjichigaadeg aabajichigaadeg mamaandaawaabik aaniin ge-izhisegiban bitaakoshkaageng ji-debinigaadeg iwe mazina'iganens. Iwe maamaw gii-izhichigem ji-debinigaadeg iwe UFTP gaye DSC-TP. Ji-gikenjigaadeg aaniin ge-maamawi-izhisegiban imaa bimiwijiganing, nitam niizhin ini gii-doojigaadewan gaa-dibaadodegin omaa e-gagwe-gikenjigaadeg aaniin ge-izhi-biigosingiban gaa-bimiwijigaadeg gaye giishpin zakideg.



Waa-gikendaming eshkam waa-onji-izhiwebak iw bimibizonitoowin gashkibijigan gaa-izhi-ozhichigaadeg, netamisingin niizh goji-gikendamowinan ozhibii'igaadewan omaa anaamiyi'ing bebezhiig ezhiwebakin giishpin daa-biigosing gashkibijigan, mii dash baamaa goji-gikendaming epiichi-gizhideg.

### Bangising Goji-gikendamowin

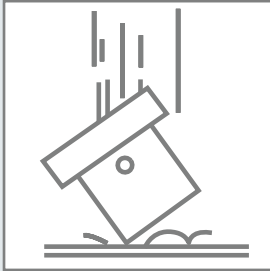

Gashkibijigan onji-bangisin Zhaangaso-diba'igan gii-ishpaag (30 zid) imaa wenji-nabagaag, gechi-mashkawaag (dibishkoo biiwaabiko-asiniikaan michisag), izhi-bakitesing ji-goji-biigosing.

Maanda goji-gikendamowin ezhichigeng ji-gikendaming ezhi-ayaag gashkibijigan apii gichi-bakitesing dibishkoo bimibizonitoong gichi-bakitesing. Bengisingin aabajitoong goji-gikendaming awashime gechi-bangisingin dash wiin bangisininig ishkode-odaabaaning apiichibizod 160 km/h bakitesininig iw bimibizonitoowin gashkibijigan. Gikenjigewin ozhibii'igaade imaa NWMO wiindamaagewining: Goji-gikendamowin Zhaangaso-diba'igan Wenji-bakitesing dibishkoo gegaa gakina gegoo bichi-doodaming (NWMO TR-2014-04).

### Wii-bagoneyaag Goji-gikendamowin

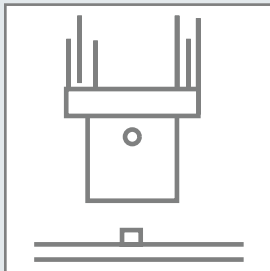

Ishkwaa-bakitesing, naasaab gashkibijigan onji-bakitesing ningo-diba'igan ishpaag (40-ninj) bakitesing imaa 15-diba'igaans (6-ninj) naawiyi'ii biiwabik gibaakwa'igan 20 diba'igaans ekwaag (8-ninj) ekwaag.

Bangising goji-gikendamowin dibishkoo bakitesing wenji-dawaag, maanda goji-gikendamowin ji-ganawaabandaming giishpin wenji-bakitesing imaa bajiiishkaag. Goji-gikendamowin ji-bagoneyaasig gashkibijiganing.

### Gizhideg Goji-gikendamowin

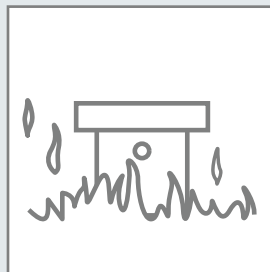

Naasaab gashkibijigan gaa-aabajitoong azhigwa gii-goji-gikendaming achigaade gichi-ishkodeng. Iw ishkode daa-apiichi-gizhide 800 degrees Celsius (1,475 degrees Fahrenheit) 30 diba'igaans daso-diba'iganeg.

Maanda goji-gikendamowin dibishkoo bachi-doodaming naniizaanaaboo zakideg besho gashkibijiganing. Gashkibijigan gakina daa-ate ishkodeng daso-diba'iganeg goji-gikendaming. Ishkode daa-apiichi-gizhide 800 degrees Celsius, ko hydrocarbon ishkode aawan. Geget bichi-doodaming, ishkodeng ategin ishkodeyaaboon gaawin zakidesinoo ko 30 diba'igaans daso-diba'iganeg ishkodeyaaboo eshkam bangii miinawaa ishkode mamaajiseg.

### Nibiing Goji-gikendamowin

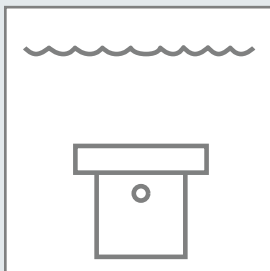

Aabajitoong gikendaasoo-makak gikenjigewin gemaa gaye zhiibinomagak goji-gikendamowinan, iw gashkibijigan goji-gikendaming dibishkoo 15 diba'igan apiichi-ishpiindimaag (50 zid) nibiing biinish 8 diba'igan daso-diba'iganeg giishpin wii-onjigaag. Iw gashkibijigan achigaade nibiing gaye goji-gikendaming 200 diba'igan apiichi-ishpiindimaag (650 zid) ji-goji-gikendaming giishpin gichi-ishpiindimaag.

Nibiin besho aazhooganing ko, miikanaang, gemaa gaye wiikwedong ganabaji bangii wiin epiichi-ishpiindimaag 15 diba'igan. Nishwaaso-daso-diba'iganeg ji-izhiwebak gashkibijigan ji-izhi-ayaag naasaab, aanawi wegodogwen daso-diba'iganeg wii-maajiidoong. Nibiing gichi-goji-gikendamowin (200 diba'igan) inendaagwad giishpin gashkibijigan gozaabiig wenji-dimiig, dibishkoo neyaashing imaa continental shelf. Agwanjitoong gashkibijigan wenji-gichi-dimiig.

## E-Gagwejichigaadeg Odaanaang Omaa

Waabanjigaade aaniin epiichi-zoogakin ini bimiwijgewinan UFTP gaye DSC-TP gii-izhiseg ginwezhiih igo, gii-gichi-gagwejichigaadegin giishpin debwe ji-zoongakin.

Daabishkoo owe

- » Gii-gagwejichigaadewan odaabaan-bimiwijiganan 1984 gii-izhiseg United Kingdom owe Central Waasigan Generating Board wiinawaa e-bimiwi-doowaad gii-naagewan dash IAEA e-gii-zhaabwiimagak bizaanigo e-gizhiibizonid odaabaanan e-gii-bichishkaagowaad 160 km e-Apiichibizonid.



- » 1999 gii-izhiseg, German Federal Institute for Materials Research gaye Teseting o-gii-baashkidewisaa-naawaa bezhig odaabaan e-biindeg waasigan, imaa dash jiiigiya'ii e-gii-ateg bezhig iwe bimiwijigan e-biindeg gaa-aakwendaagwak waasiganaabo. Gii-gwaashkwesin imaa bimiwijiganing biinish mitakamig e-gii-izhi-biindakami-giseg awashime nisimidana daso-mizid e-gii-izhiseg. Gaawiin dash gii-bakoji-isesinon iwe bimiwijigan, bangii eta imaa ogijiya'ii gii-naagwan e-gii-izhising gegoon.



Mii gii-gikendaagwak e-gii-zhaabwiimagakin ini gaa-bimiwijigaadegin, gaawiin e-gii-ziigisinzinog gegoon.

## Noongom NWMO ezhichigemagak

Iwe NWMO gaa-izhinikaadeg o-da-gagwejitoonan ini bimiwijgewinan ji-gagwe-gikendaagwak giishpin ji-zoongakin gaye ji-nanaando-gikendang aaniin giyaabi ge-izhi-minochigaadegin.

# 8 Ji-Maanzhisesinog Gii-bimiwijigaadegin ini

Iwe izhichigewin NWMO gaa-izhinikaadeg da-waabanda'uwe ji-minoseg gaa-izhi-ganawenjigaadeg noongom ajina onji-bimiwijigaadeg iwe gaa-aakwendaagwak ishkwaakizigan, wedi dash ge-izhi-nepiji-ningwa'igaadeg, gaawiin gegoo ji-izhisesigwaa bemaadiziwaad gaye aki.

Zhaabwaateshkaawin mikigaade naanoojigo e-ayaag. Anaamakamig ayaadog iwe zhaabwaateshkaawin endaso-giizhig gegoo gaa-onji-ozhichigaadeg, gaa-bagidanaamoying, miijim, waasa giizhigong, gaye giinawind gaa-onji-ozhi'oying.

Iwe dash minik zhaabwaateshkaawin gaa-megwaashkamang aapiji bangii iwe. Iwe CNSC Zhaabwaateshkaawin Inaakonigewin izhisin imaa mazina'iganing aaniin minik ge-ako-zhaabwaasogooaapan awiyag awenenag igo, 1 mSv endaso-biboon. Iwe ngojigo aabita ge-ayaawaapan awiyag 1.8 mSv endaso-biboon.

Iwe izhichigewin CNSC ikidoomagan Zhaabwaateshkaawin Inaakonigewin ji-inaakonigeng aaniin minik ge-ako-ayaawaapan zhaabwaateshkaawin igi gaa-anokiiwaad imaa. Owe minik 50 mSv

endaso-biboon daa-ako-ayaanaawaa gaye maawach 100 mSv naano-biboon ako.

Iwe CNSC odaabajitoonaawaan aakoziwi-nanaandogikenjigewinan gaye enisidotamowaad aaniin ezhisemagak iwe zhaabwaateshkaawin ji-mino-wiji'igowaad Kaanada akiing gaa-ayaawaad awiyag iwe inaakonigewin. Iwe CNSC gaye bakaan inaakonige-izhichigewinan gii-atonaawaan ge-ako-ayaagiban zhaabwaateshkaawin gaye ji-atooaad inaakonigewin ji-ozaami-ayaasinog zhaabwaateshkaawin.

Omaa da-wiindamaagemagan aaniin minik zhaabwaateshkaawin ge-ayaagiban gaye aaniin ge-inishkaagemagakiban giishpin ozaam awiya zhaabwaateshing.

## Wegonen iwe mSv gaa-ijigaadeg?

Iwe mSv milliSievert izhinikaade izhi-wiinde dash aaniin ge-inishkaagopan awiya giishpin zhaawateshing ozaam.

Waasamowin-ayaawin	Apiich gemaa gaye Izhi-ayaawin
Awashime wiin 5,000 mSv	Waasamowin-ayaawin wii-onji-nibom giishpin gakina
1,000 mSv	Waasamowin-ayaawin wii-onji-ozhitoong waasamowinaapinewin (e.g. ayekoziwin miinawaa maazhide'ewin) giishpin odaapinigaaadeg 24 daso-diba'ganeg
100 mSv	Bangiishens waasamowin-ayaawin waa-onji-ozhichigaadeg agomowaapinewin
30–100 mSv	RWaasamowin-ayaawin gakina wiiyaw nanagikenjigaadeg gikendaasoo-makakoong mazinaakizon (CAT)
50 mSv	Endaso-gikinoonowin waasamowin-ayaawin apiich wenji-ayaawaad naniizaanaaboo-waasamowin enanokiiijig
1.8 mSv	Mayena endaso-gikinoonowin Canadian bagwaji-waasamowin-ayaawin
1 mSv	Endaso-gikinoonowin bemaadizijig apiich waasamowin-ayaawin
0.1–0.12 mSv	Waasamowin-ayaawin opan gaa-zhaabwaatesidoong
0.01 mSv	Waasamowin-ayaawin owiibidan gaa-zhaabwaatesidoong
0.01 mSv	Mayena endaso-gikinoonowin waasamowin-ayaawin ishpiming babaamaadizing

Omaa onjiimagan owe wiindamaagewin: CNSC website – Radiation Health Effects [www.nuclearsafety.gc.ca/eng/resources/radiation/introduction-to-radiation/radiation-health-effects.cfm](http://www.nuclearsafety.gc.ca/eng/resources/radiation/introduction-to-radiation/radiation-health-effects.cfm)

## Zhaabwaateshkaawin ge-izhisegiban imaa gaa-izhi-ayaawaad awiyag Megwaa Bimiwijigaadeg iwe Ishkwaakizigan

Jibwaa-bagidinamowaad igi gaa-inaakonigewaad ji-bimiwijigaadeg iwe ishkwaakizigan UFTP gemaa gaa-baateg gaa-izhi-biindeg, NWMO da-inaawag ji-waabanda'iwewag owe minik daa-apiichi-naniizaanendaagokiban iwe bimiwijigewin gaa-aakwendaagwak ishkwaakizigan 1 mSv endaso-biboon.

Iwe minik e-andawendamowaad ji-bimiwidoowaad endaso-biboon gaye gaa-izhichigaadeg noongom iwe UFTP, gaawiin aapji da-naniizaanendaagwazinoon iwe bimiwijigewin inendamowag.

Noongomiike gii-nanaando-gikenjigaade aaniin minik ge-izhi-naniizaani'igowaapan igi gaa-daawaad jigiya'ii iweni bimiwijigewin aabajichigaadeg UFTP. Igi bemaadiziwaad gaa-daawaad imaa ge-bimi-izhaamagak iwe bimiwijigewin gemaa ge-bimi-ayaawaad gewiinawaa imaa gemaa igiwe ge-bimi-gibichiiwaad gaa-bimi-izhaamagak iwe bimiwijigewin gii-naagadawaabamaawag. Gaawiin aapji daa-naniizaanisesiiwag gii-inenjigaade.

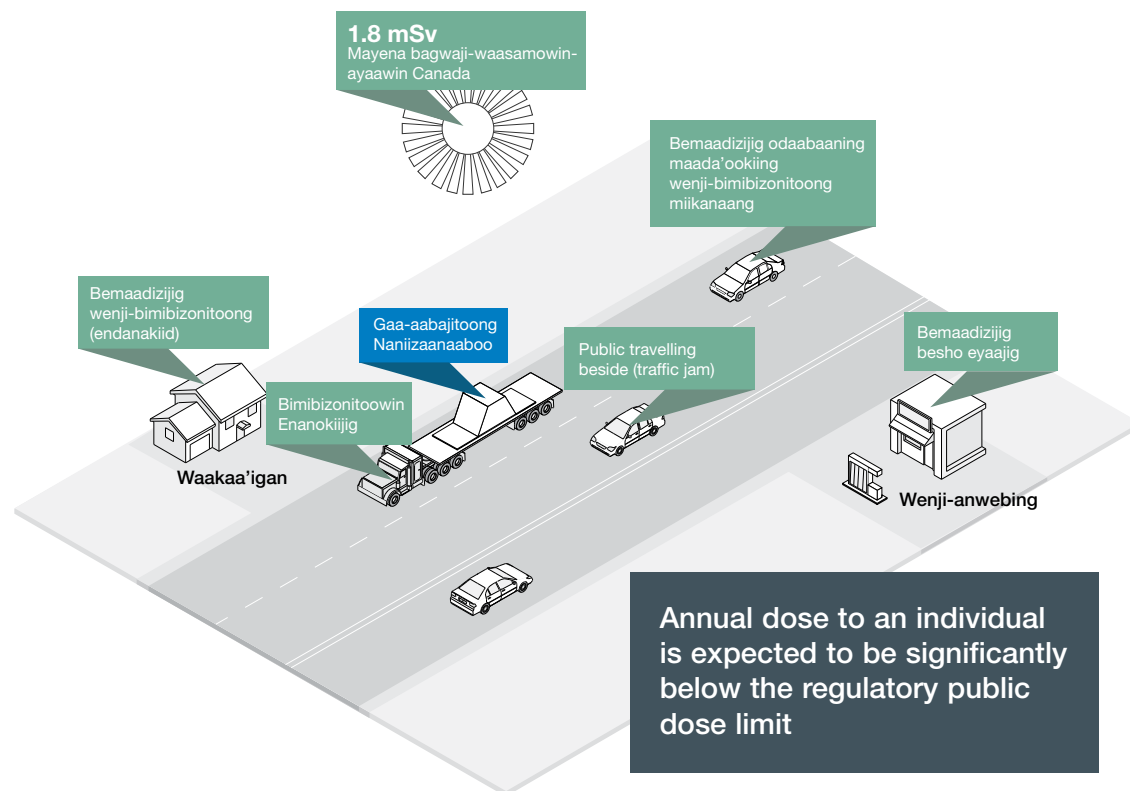

## Zhaabwaateshkaawin ge-izhishkaagowaapan igiwe Gaa-bimiwijigewaad Odanokiig

Daabishkoo iwe nanaando-gikenjigewin gaa-ishkwaa-wiindeg, bezhig miinawaa gii-doojigaade, noongom dash e-ganawaabamindwaa igiwe odanokiig ge-bimibizowaad ini odaabaana' gaa-izhi-bimiwijigaadeg iwe gaa-aakwendaagwak ishkwaakizigan aabajichigaadeg iwe UFTP.

Gii-ganawaabamaawag igi odanokiig apii gii-onji-maajaawaad imaa gaa-gii-izhi-boosichigaadeg iwe bimiwijigan apii dash wedi gii-dagoshinowaad gaa-wii-izhi-ningwa'igaadeg. Amii dash gaa-izhi-waabandamowaad gaawiin aapji daa-naniizaanisesiiwag igi odanokiig.

# 9 Bimiwijigewin Inaakonigewin gaye Ge-banaabanjigaadegiban

Omaa Kaanada akiing weweni ji-bimiwijigaadeg iwe gaa-aakwendaagwak ishkwaaakizigan niizhwewanagiziwag gaa-inaakonigewaad, bezhig CNSC miinawaa dash Bimiwijigewin Kaanada.



Iwe CNSC inaakonigewag ji-bimiwijigaadeg iwe gaa-aakwendaagwak ishkwaaakizigan owe inaakonigewin Ozhichigaadeg Ge-izhi-bimiwijigaadeg gaye dash Bimiwijigaadeg gaa-aakwendaagwak ishkwaaakizigan Inaakonigewin (*PTNSR*).

Iwe dash *PTNSR* inaakonigewin izhiwiinde gakina iwe ge-ganawaabanjigaadeg ji-izhiseg apii gii-onji-maajaawaad biinish dash dagoshinowaad gaa-izhaawaad. Owe ganawaabanjigaade:

- » Ji-izhichigewaad gaa-inaakonindwaa ji-izhi-bimiwijigewaad
- » Ji-izhitoowaad iwe bimiwijigan gaa-inaakonindwaa
- » Ji-ozhibiwaawaad gakina igi ge-aabajitoowaad ini bimiwijiganan
- » Ji-ayaawaad izhichigewin weweni ge-onji-anokiiwaad igi odanokiig gegoon ji-izhi-maanzhisesigwaa
- » Ji-miigiweng mazina'iganens baamaa gaa-ishkwaa-ozhitoowaad aaniin ge-izhichigewaad giishpin gegoon izhi-maanzhiseg gaye gaa-ishkwaa-bagidinindwaa
- » Ji-ayaawaawaad odanokii' ge-ashowizinid endaso-giizhig bizhishig igo maadg-izhaa gegoon izhi-maanzhiseg megwaa bimiwijigaadeg iwe
- » Ji-waawaabanjigewaad weweni giishpin gegoon izhi-maanzhiseg
- » Ji-naagajitoowaad gakina iwe ge-doodamowaad giishpin gegoon izhi-maanzhiseg
- » Ji-naagadawaabandamowaad gwayak naanaagadawaabanjigewin.

Jibwaa-bimiwidoowaad ishkwaaakizigan omaa Kaanada akiing, iwe CNSC o-gii-andawendaanaawaa mazina'igan ji-ayaak iwe bimiwijigan gaye ji-aabadak ji-bimiwijigaadeg iwe ishkwaaakizigan. CNSC onaagadawaabandaanaawaa ini gagwedwewinan ji-izhiseg gakina ji-wii-izhichigewaad gaa-wii-bimiwijigewaad gwayak ji-doodamowaad. Owe memindage:

- » Ji-gikino'amawindwaa odanokiig gaye igi ge-dagoshinowaad giishpin gegoon izhi-maanzhiseg
- » Ji-naagajichigaadeg izhichigewin ji-naniizaanadazinok anokiiwin
- » Ji-ayaawaad ge-izhichigeng giishpin gegoon maanzhiseg
- » Ji-ayaawaad ge-ayaamagak imaa ji-ganawenjigaadeg gakina gegoon
- » Ji-ganawenjigaadegin gaa-ozhibii'igaadeg gaa-izhiseg gakina gegoon
- » Ji-biminizha'amowad gakina inaakonigewinan.

Ayaamagan CNSC ozhibii'igan Bimiwijiganan ge-izhinaagwakin gaye Weweni Bimiwijigaadeg Ishkwaaakiziganan Omaa Kaanada akiing Inaakonigewin, omaa dash daa-ondinigaade izhi-maamaagonigeng: [www.nuclearsafety.gc.ca](http://www.nuclearsafety.gc.ca).

CNSC gaye wiindamaagewag wegonen maawach gwegwejimindwaa aaniin dash gaye ezhi-nakwetamowaad imaa maamaagoniganing.



Iwe *PTNSR* oganawaabandaanaawaa iwe izhichigewin Miziwe Akiing Gaa-aakwendaagwak Waasigan Gaa-Naagajitoowaad IAEA ji-biminizha'amowaad ge-izhichigewaad. Giiyaabi wii-gikendameg iwe IAEA omaa izhi-maagonigeg [www.iaea.org](http://www.iaea.org).



Bimiwijigewin Kaanada odayaanaawaa mazina'igan owe e-izhinikaadeg Bimiwijigaadegin gaa-naniizaanendaagwakin Inaakonigewinan, amii dash ezhi-wiindeg wegonen ge-izhi-biminizha'igaadeg daabishkoo gikino'amaagewin, aaniin ge-izhichigeng gegoon maanzhiseg, gaye ge-izhi-minoseg gaye ozhibii'igewin.

Bimiwijigewin Kaanada owe izhi-bagosendaagoziwag ji-izhi-bimiwidoowaad gaa-aakwendaagwaninig gegoon:

- » Ji-ozhitoowaad wegonen ge-biminizha'amowaad inaakonigewin igi ge-anoki-iwaaad gaye igi ge-bimiwijigewaad
- » Ji-ikidowaad wegonen ge-naanaagadawaabanjigaadeg daabishkoo gikino'amaagewin gaye ozhibii'igewin gaye
- » Ji-ikidowaad wegonen ge-izhichigeng giishpin gegoon gichi-maanzhiseg.

Bimiwijigewin Kaanada odaayaawaa izhichigewin CANUTEC e-izhinikaadeg e-wiji'iwemagak giishpin gichi-maanzhiseg gegoon gi-bimiwijigaadeg gaa-naniizaanendaagwakin gegoonan, bizhishig igo ashowiziwag. Niizhweg gaa-izhigiizhwewaad, gaa-baakwaa'ishiiimowaad gaye gaa-zhaaganaashiimowaad odanokiig imaa ayaawagji-wiji'iwewaad. Gaa-zanagak izhigiizhwe-win ogikendaanaawaa wiji'iwewag dash.

Bimiwijigewin Kaanada odinaakonigewininiwaa ji-bimiwijigaadegin gaa-naniizaanendaag-wakin gewinawaa akiikaanan gaa-izhi-dibendaagoziwaaad naasaab obiminizha'aanaawaan ini.



Akiikaanan ogimaawinan gaye gaa-inaakonigewaad, gaye ogimaawinensan bagosendaagoziwag ji-doodamowaad ji-biminizha'igaadegin ini inaakonigewinan, gaye naanaagadawaabanjigewin gaye ji-wii'ijiwewaad giishpin gichi-maanzhiseg gegoon gi-bimiwijigaadeg.

# Ge-inaakonigeng



Transport Canada / Transports Canada

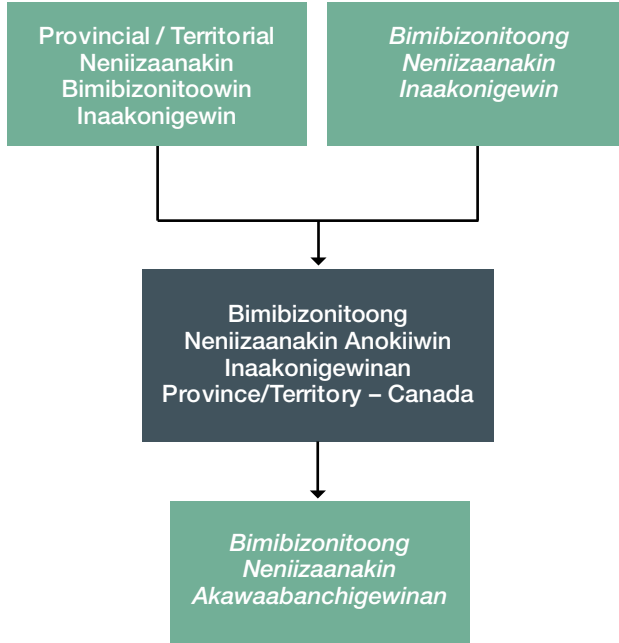

Canadian Nuclear Safety Commission / Commission canadienne de surete nucleaire

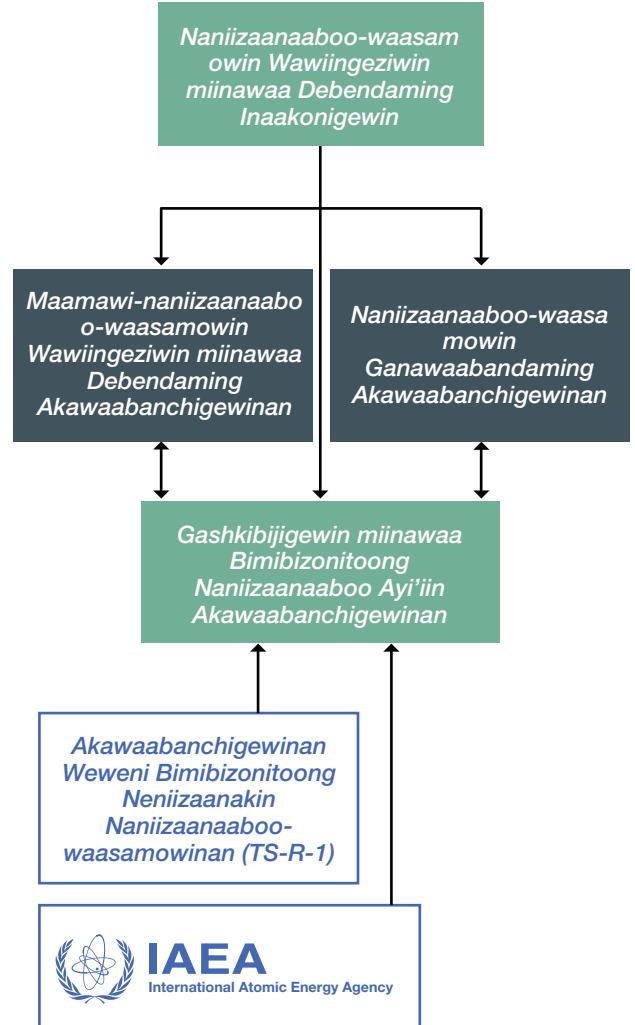

# 10 Ge-inwaadeg iwe NWMO Gaa-izhinikaadeg gaye Gaa-izhi-bagosenimindwaa ji-izhichigemagak

Iwe NWMO gaa-izhinikaadeg da-bagosendaagwan ji-doodamowaad weweni ji-bimiwijigaadeg iwe gaa-aakwendaagwak ishkwaakizigan imaa gaa-izhi-ganawenjigaadeg noongom, iwedi dash ji-izhiwidoowaad ge-izhi-ningwa'igaadeg gaa-izhi-asiniikaag. Iwe CNSC gaye Bimiwijigewin Kaanada bagosendaagoziwag inaakonigewininan ji-biminizha'igaadeg.



## Wiindamaagewin / Giigidowin

Iwe NWMO-ing da-onjiimagan gakina ge-onji-wiindamaadiwaad gakina gaa-dagwiiwaad bimiwijigaadeg iwe ishkwaakizigan. Amii imaa ge-onjisege ji-wiindamaadiwaad aandi eyaag iwe bimiwijigan, gaye aandi eyaad awe gaa-bimibizod, gaye aaniin ezhiwebak, aaniin endashiwaad godak gaa-bimibizowaad odaabaanag gaye enamok gaye da-izhise ji-ganoonind awe gaa-bimibizod, igi gaye ge-naagajichigewaad gaye gaa-inaakonigewaad gaye igi ge-wiiji'iwewaad giishpin gegoon maanzhisege, gaye iwe Bimiwijigewin Kaanada gaye CANUTEC gaye CNSC.

Megwaa bimiwijigaadeg iwe ishkwaakizigan, da-ayaamagan giigidowin daabishkoo gaa-gii-ikidowaad ji-doodamowaad. Amii ogo ge-ganoonindiwaad:

- » Bimiwijigewin gaa-izhi-maajisege;
- » Ge-wiijiwiwed bimiwijigaadeg iwe ishkwaakizigan;
- » Gaa-gii-onjiwijigaadeg iwe ishkwaakizigan;
- » Ge-dazhi-ningwa'igaadeg;
- » Gakina ge-ayaawaad igi ge-wiiji'iwewaad giishpin gegoon maanzhisege aaniindi go akiikaaning ge-bimi-ayaang.

Giishpin gegoon izhisege, iwe bimiwijigewin gaa-izhi-maajisege da-ganoonaawag. Apii ganoonindwaa, gaa-niigaaniid imaa o-da-ganoonaa' ini akiikaaning gaa-gii-izhisege iwe ji-wiiji'iwewaad. Amii dash igiwe ge-izhi-ganoonaawaad ini gaa-ashowizininid ge-gii-bimi-ayaagiban iwe bimiwijigewin.





## Ge-izhi-Nakwetamowaad Gegoon Maanzhiseg

Iwe NWMO o-da-miinaawaan waa-izhichigewaad giishpin gegoon izhi-maanzhiseg ini CNSC-an, gakina dash iwe wiindamaagewin da-debwemagan gaye gakina awiyag ji-nisidotamowaad. Iwe NWMO gaye da-wiiji'iwe ji-ayaaniwang aaniin ge-izhichigeng gegoon gichi-maanzhiseg ji-dazhiikamowaad iwe ishkwakizigan.

Amii enwaadeg iwe ashowizwin weweni ji-wiiji'idiwaad igiwe NWMO gaye akiikaaning gaa-onji-dibendaagoziwaad gaye igi besho oodenaang gaye oniigaaniig gaye gichi-ogimaawining gaa-izhi-dibendaagoziwaad, ge-nakwetamowaad iwe wiindamaagewin. Amii ezhising iwe mazina'igan gaa-wiindeg aaniin ge-izhichigeng giishpin gegoon maanzhiseg (2<sup>nd</sup> ozhibi'igan - January 2011) gakina gaa-daswewaanagiziwaad ogimaawinan da-gagwejiimaawag ji-dagwiwaad gegoon gichi-maanzhiseg. Akiikaanan gaye besho imaa oodenaang gaa-anokiwaad gaye gaa-ogimaawiwaad imaa da-bagosenimaawag ji-nakwetamowaad iwe. Gichi-ogimaang gaye gaa-onjiwaad da-wiiji'iwe wag gagwejiimindwaa ji-doodamowaad.

Dago wiiji'aawaad ini akiikaaning gaa-ayaawaad, iwe NWMO oda-niigaanishkaan ge-izhichigeng ji-onwaadamowaad ge-izhichigewaad, ji-gikino'amaagewaad aaniin ge-izhichigeng, gaye ji-gojiitoowaad aandi ge-izhaaniwang. Gagwejiwaad amii iwe ji-gikino'amaagewaad, ji-wiindamaagewaad gaye ji-onwaadamowaad ge-izhichigewaad, gaye babenak ji-izhichigewaad gichi-maanzhiseg. Da-gagwejiichigaade aaniin ge-izhi-minoseg iwe. Amii ezhi-misawendang awe NWMO weweni ji-ashowizong, gwayak gaye ji-izhichigeng apii gegoon maanzhiseg megwaa-bimiwijigaadeg iwe gaa-aakwendaagwak ishkwakizigan.

Omaa Kaanada akiing, igi gaa-ashowizowaad o-da-aabajitoonaawaa wegonen igo ji-izhi-doodamowaad giishpin gegoon gichi-maanzhiseg, wegonen igo izhiseg. Gaa-niswewaanagi-ziwaad ogimaag daabishkoo gichi-ogimaa, akiikaan ogimaa, gaye oodenaang gaa-ogimaawid ji-gikendamowaad aaniin ge-doodamowaad gegoon izhiseng. NWMO oda-wiidanokiimaa' ini ogimaa' ji-ayaamagak gikino'amaagewin gaye aabajichigan ge-onji-mino-wiiji'iwe waad igi ge-dagoshinowaad nitam gegoon gichi-maanzhiseg imaa miikanaang. Amii iwe ashowiiwin ge-biminizha'ang NWMO ji-gwayaanjiitoowaad iwe gaa-wii-bimiwijigaadeg iwe ishkwakizigan.



## Ji-naniizaanendaagwasinog

Iwe NWMO bagosendaagozi ji-onwaadang aaniin ge-izhi-bimiwijigeng gegoon dash ji-maanzhisesinog. Maawach da-gagwe-ashowizo gegoon ji-izhisesinogin ini ge-bimiwijigaadegin endaso-giizhig, weweni ji-dagoshinoomagakin gaa-izhaamagakin. Bizhishig da-ganawaabanji-gaade ji-minosegwen.

Iwe ge-ganawaabanjigaadeg ji-manaa-bakebideg iwe gaa-bimiwijigaadeg gemaa awiya ji-biigobidoosig onjida igo, aapiji go da-aayijichigaade awiya gegoon ji-doodanzig, ji-ayaagin gaye ge-noondaagwakin giishpin gegoon amanisoomagak e-wii-izhiseg, ji-mazinaateshimiwe-magak gaye ji-gikenjigaadeg aaniin mayaa enakamigak, giishpin awiya waabandazig, gaye ji-ayaamagak giigidowin bizhishig maagizhaa gegoon izhiseg. Weweni da-naagajichigaade iwe gaa-aakwendaagwak ishkwakizigan bimi-ayaamagak, maagizhaa awiya onjida gegoon gagwe-doodang, gaye iwe 5 naanan gaa-izhibii'igaadeg mazina'iganing gaa-izhibii'igewaad CNSC.

Amii ge-izhichigewaad igi CNSC weweni ji-onwaadamowaad aaniin ge-izhi-bimiwijigewaad bizhishig ji-ganawaabanjigaadeg, gaye naanigoding ji-ganawaabanjigaadeg iwe, bizhishig ji-ashowiziwaad.

CNSC inaakonigewinan ikidoomaganoon ji-biminizha'igaadegin onoweniwan megwaa bimiwidoowaad iwe ishkwakizigan gaa-aakwendaagwak:

- » Da-bimi-ayaa awiya ge-naagajitood ini bimiwijiganan gaye bizhishig ji-ganawaabandang;
- » Da-miigiwem mazina'igan gaa-wiindeg aaniin ezhichigeng ji-manaa-maanzhiseg iwe gaa-bimiwijigaadeg. Da-ozhibii'igaade aaniin mayaa waa-izhichiged awe gaa-bimiwijiged gegoon ji-izhisesinog gaa-bimiwijigaadeg.
- » Da-onwaade niigaan ji-ganoonindwaa gakina igiwe gaa-babaamiziwaad ge-bimi-ayaawaad gaye ge-ganoonindwaa giishpin gegoon izhiseg, ji-waawaabanjigaadeg bimiwijigan jibwaa-maajaang, gaye ji-gikenjigaadeg ge-izhichigeng ani-gibichiing ngoji gemaa giishpin wiikaa maajaanaaniwang giishpin izhiseg;
- » Da-anokii'aawag gaa-inanokiiwaad ji-ganawaabandamowaad aaniin ge-izhiseg-iban megwaa bimi-ayaamagak iwe bimiwijigan, ji-maanzhisegiban, ji-gikenjigaadeg wegonen ge-onji-minosegiban nawach.
- » CNSC gii-waawiindamaagewag wegonen ge-minoseg ji-izhi-mino-bimiwijigaadegin iwe ishkwakizigan. Gakina iwe wiindamaagewin gaawiin wiin awenen igo o-daa-gikendanzin, ozaam gaawiin daa-minosesinoon gakina awiya ji-gikendang. Igi eta gaa-babaamiziwaad da-wiindamawaawag iwe.

# 11 Ezhiseg Agaamakiing wiin

Niibiwa akiin agaamakiing odoozhitoonaawaan aaniin gewiinawaa ge-doodamowaad weweni ji-bimiwidoowaad iwe gaa-aakwendaagwak ishkwakizigan. Aazha o-gikendaanaawaa ge-doodamowaad omaa Kaanada akiing gaye miziwe agaamakiing.

Awashime 50 naanimidana daso-biboon gaa-izhiseg, gaawin gegoon bi-maanzhisesinoon, awiyag ji-jaagizowaad, gegoon ji-inaapinewaad, ji-nisigowaad, gaye aki gegoon ji-izhiseg gii-onji-bimiwijigaadeg iwe gaa-aakwendaagwak ishkwakizigan.

Ogimaawinan gaye gaa-inaakoni-gewaad gaye gaa-zhooniyaakegin izhichigewinan omaa Kaanada akiing gaye miziwe akiing agaamakiing aazha onagajitoonaawaa owe e-bimiwidoowaad owe dinookaan gegoon. Omaa wiin Kaanada akiing, aapiji niibiwa ini maawadoopijiganan bimiwijigaadewan endaso-biboon. 1970 gii-izhiseg Kaanada aki ngojigo naanwaa ini ishkwakiziganan ya'iing gaa-izhi-ozhichigaadeg iwe waasigan gii-onjiwijigaade wedi dash Atomic Energy Kaanada akiing Limited's Chalk River Gaa-danakamigak gii-onjiwijigaadewan e-gii-izhiwijigaadeg, ji-nanaando-gikenjigaadeg iwe ishkwakizigan.

Iwe Miziwekamig Atomic Energy Izhichigewin, gichi-ogimaawinan gaye

gaa-nishike-anokiwaad miziwe agaamakiing, memindage Gichi-Mookomaanakiing, gaye Zhaaganaashiiwakiing, Agaamakiing, gaye Diikewakiing o-waawaabandaanaawaa gaye onaanaagadawaabandaanaawaa onowe bimiwijigewin.

Imaa Gichi-Mookomaanakiing gegaa 3,000 daswaa obimiwidoonaawaa iwe ishkwakizigan awashime 2.5 gichi-daswaak oshki-diba'akaan aazha 40 niimidana daso-biboon e-izhiseg, miikanaang gaye ngoding ishkode-odaabaanikanaang e-bimiwijigaadeg. Imaa Zhaaganaashii-wakiing gaye Paakwaa'ishiiwakiing awashime 550 daswaa obimiwidoonaawaa iwe gaa-aakwendaagwak ishkwakizigan endaso-biboon ishkode-odaabaanikana e-aabadak. Wedi dash Zwiidin gaa-izhinikaadeg aki agaamakiing ngoji go 40 daswaa endaso-biboon obimiwidoo-naawaa iwe jiimaaning, gaye wedi Japaan akiing ngojigo 200 daswaa ogii-bimiwidoonaawaa jiimaaning.



Gii-wiiji'iwewag Akiing Waasiganikewin Bimiwijigewin Izhichigewin

Minik lidog  
Gashkibijiganan

Dinowa  
Bimibizonitoowin

 Miikana

 Ishkode-odaa  
baani-miikana

 Nibi

Canada

 Naanan Endaso-  
gikinoonowin

United Kingdom

 Niswaak Endaso-  
gikinoonowin

United States

   Nisosagoons  
biinish noongom

France

 Niizhosagoons-ashi-  
niizhdana-ashi-naanan

Mii Waabanda'aming  
Gaa-izhichigeng  
Gaa-bimibizonitoong  
Weweni Gaa-aabajitooong  
Naniizaanaaboo Canada  
miinawaa Gakina Ningoji



Sweden



Niimidana Endasogikinoonowin

Germany



Niimidana Endasogikinoonowin

Japan



Niizhwaak biinish noongom

# 12 Gaa-ondinigaadeg Gaa-dazhindeg

Ozhibii'iganan gaye maamaagoniganan gaye gaa-mazinaatesegin

## **Gaa-aakwendaagwak ishkaakizigan Ji-Naagajichigaadeg Izhichigewin [www.nwmo.ca](http://www.nwmo.ca)**

- » Bimiwijigaadeg Kaanada akiing Gaa-aakwendaagwak ishkaakizigan
- » Naanekaw Ji-Naagajichigaadeg Izhichigewin odizhinikaadaanaawaa
- » Bezhigwanong ji-inaabing ji-mikigaadegin ozhibii'iganan, gaa-mazinaatesegin, waabanda'iwe-mazina'iganan gaye giyaabi
- » Weweni ji-ganawenjigaadeg iwe Gaa-aakwendaagwak Ishkaakizigan omaa Kaanada
- » Ji-ganawaabanjigaadeg aaniin ge-izhisepan awiya zhaabwaasod
- » Ji-ganawaabanjigaadeg aaniin ge-izhisepan odanokii zhaabwaasod
- » Dakokiiwin 3, Nitam 1 Ge-ganawaabanjigaadegin nitam Iwe mazina'igan 6 - Akawe ge-ganawaabanjigaadeg Bimiwijigewin

## **Kaanada aing Minochigewin Izhichigewin [www.nuclearsafety.gc.ca](http://www.nuclearsafety.gc.ca)**

- » Zhaabwaateshkaawin Ezhisemagak giyawing
- » Bezhigan ji-inaakonigaadeg Gii-bimiwijigaadeg iwe Gaa-aakwendaagwak ishkaakizigan omaa Kaanada akiing
- » Maawach gaa-gagwedweng e-dazhinjigaadeg iwe gii-bimiwijigaadeg gaa-aakwendaagwak ishkaakizigan
- » Inaakonigewin ewiindamaageng edazhinjigaadeg ji-maanzhisesinog gii-bimiwijigaadeg iwe ishkaakizigan imaa bakeya'ii I miinawaa II miinawaa III gaa-aakwendaagwak ishkaakizigan. (G-208)

## **Bimiwijigewin Kaanada: [www.tc.gc.ca](http://www.tc.gc.ca)**

- » Ashowizowin Gegoon Maanzhiseg

## **Waasa Agaamakiing Atomic Energy Izhichigewin [www.iaea.org](http://www.iaea.org)**

- » Bimiwijigaadeg Gaa-aakwendaagwak Ishkaakizigan

## **Akiing Gaa-aakwendaagwak gegoo bimiwijigaadeg Izhichigewin: [www.wnti.co.uk](http://www.wnti.co.uk)**

For more information, please contact:

**Nuclear Waste Management Organization (NWMO)**

22 St. Clair Avenue East, Sixth Floor

Toronto, Ontario M4T 2S3 Canada

Tel: 416.934.9814

Email: [contactus@nwmo.ca](mailto:contactus@nwmo.ca)

Website: [www.nwmo.ca](http://www.nwmo.ca)

**nwmo**

NUCLEAR WASTE  
MANAGEMENT  
ORGANIZATION

SOCIÉTÉ DE GESTION  
DES DÉCHETS  
NUCLÉAIRES